



**BETTCHER**  
Industries, Inc.

---

**Operating Instructions & Spare Parts List for the**

**BETTCHER®**

**AutoEdge**  
**Automatic Blade Sharpener**

**Manual # 185321**

Re-Issued: June 15, 2018

TMC #827

For Assistance, Write:

**BETTCHER INDUSTRIES INC.**

P.O. Box 336

Vermilion, Ohio 44089-0336

U.S.A.

Phone: 440/965-4422

Phone: 800/321-8763

Fax: 440/328-4535

*Internet: <http://www.bettcher.com>*

Information in this document is subject to change without notice.

No part of this document may be reproduced or transmitted in any form or any means, electronic or mechanical, for any purpose, without the express written permission of Bettcher Industries Inc.

Written permission to reproduce in whole or part is herewith granted to the legal owners of the Bettcher® AutoEdge with which these Operating Instructions have been supplied.

Operating Instructions in other languages are available on request. Additional copies of Operating Instructions are available by calling or writing the local Representative or by contacting:

BETTCHER INDUSTRIES, INC.  
P.O. Box 336  
Vermilion, Ohio 44089-0336  
U.S.A.

Telephone : 440/965-4422  
(In The U.S.A.) : 800/321-8763  
Fax : 440/328-4535

The Information Provided In These Operating Instructions Is Important To Your  
Health, Comfort And Safety.  
For Safe And Proper Operation, Read This Entire Manual Before Using This  
Equipment.



Copyright © 2018 by Bettcher Industries, Inc.  
All Rights Reserved  
Original Instructions

## Table of Contents

**Section 1.....*Safety and Ergonomics***

**Section 2.....*Designated Use***

**Section 3.....*Unpacking and Installation***

**Section 4.....*Instructions for Operation***

**Section 5.....*Maintenance***

**Section 6.....*Cleaning***

**Section 7.....*Service Parts***

**Section 8.....*Contact and Document Information***

**BETTCHER®**  
**AutoEdge**  

---

**Automatic Blade Sharpener**



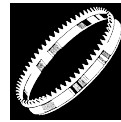

# **Section 1**

## **Safety and Ergonomics**

### **CONTENTS OF THIS SECTION**

Safety Recommendations and Warnings .....	1-2
Safety Features .....	1-4
Ergonomics and Environment.....	1-4



## Safety Recommendations and Warnings

Any use in applications other than those for which the Bettcher® AutoEdge was designed and built may result in equipment damage and/or serious injuries.

**Warnings** identify conditions that can cause serious bodily injury to the user.

**Cautions** identify conditions that are important to the operation, care and maintenance of the machine.



**W A R N I N G**

**THE MANUFACTURER ASSUMES NO LIABILITY FOR ANY UNAUTHORIZED DESIGN CHANGES, MODIFICATION, OR USE OF PARTS NOT SUPPLIED BY THE MANUFACTURER OR THE USE OF PARTS NOT DESIGNED FOR USE ON THIS SPECIFIC MODEL, AND INCLUDES CHANGES IN OPERATING PROCEDURES MADE BY THE OWNER OR ANY OF HIS PERSONNEL.**

**FOR SAFE AND PROPER OPERATION, READ THE ENTIRE MANUAL BEFORE USING THIS EQUIPMENT.**







**W A R N I N G**

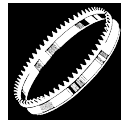





**ELECTRICAL SHOCK MAY OCCUR! ALWAYS DISCONNECT UNIT FROM POWER SUPPLY PRIOR TO SERVICING.**



**Safety Recommendations and Warnings (Continued)**

  **WARNING**  

**SHARP BLADE MAY CAUSE CUT INJURY! FOR PROPER PROTECTION OF HANDS, PROTECTIVE GLOVES SHOULD BE WORN WHEN OPERATING THIS EQUIPMENT AND DURING THE HANDLING OF BLADES.**

  **WARNING**  

**ELECTRICAL SHOCK MAY OCCUR! USE ONLY 3-WIRE GROUND TYPE CONNECTOR. THIS MUST BE CONNECTED TO A PLANT GROUND VIA A SUITABLE GROUNDED THREE CONDUCTOR RECEPTACLE. AVOID USE OF THIS MACHINE IN STANDING WATER.**



 **WARNING** 

**EYE INJURY MAY OCCUR! NEVER OPERATE THIS MACHINE WITHOUT THE EYE SHIELD IN PLACE AND PROPER EYE PROTECTION WORN.**



---

## **Safety Recommendations and Warnings (Continued)**

		<b><u>W A R N I N G</u></b>	
<b>KEEP THE MACHINE AND SURROUNDING AREA CLEAN FROM BUILDUP OF GRINDING DUST. A BUILDUP OF METAL DUST CAN BE A FIRE HAZARD.</b>			

### **Safety Features**

The Bettcher® AutoEdge Blade Sharpener is equipped with an eye shield to deflect grinding particles away from the operator.

### **Ergonomics and Environment**

This equipment should be operated while standing in a comfortable and secure position.

The noise emission value is less than 85 db.

### **NOTICE**

The manufacturer assumes no liability for any unauthorized changes in operating procedures or for unauthorized changes or modifications made to the design of the machine or any factory-installed safety equipment, whether these changes are made by the owner of this equipment, by his employees, or by service providers not previously approved by Bettcher Industries, Inc.





# Section 2

# Designated Use

## CONTENTS OF THIS SECTION

Machine Specifications .....	2-2
Electrical Specifications .....	2-2
Designated Use .....	2-2
Machine Function .....	2-2



---

## Machine Specifications

Weight	53.5 lbs. (20.0 Kg)
Overall size (with eye-shield)	14" wide x 18" deep x 22" high (35.6cm x 45.7cm x 55.9cm)
Power cord length	6 feet (1.83 meters)

## Electrical Specifications

Power Source:	115/230VAC / 1 Phase / 60/50 Hz	150W
---------------	---------------------------------	------

## Designated Use

The Bettcher® AutoEdge Blade Sharpener has been designed to sharpen only Bettcher Whizard® Trimmer blades.

## Machine Function

The Bettcher® AutoEdge Blade Sharpener is a precision grinding unit that is easy to operate and maintain. It will produce consistently sharp blades when used properly.

With a blade installed in the blade holder, the cycle switch is pushed to start the automatic blade sharpening cycle. The blade holder and grinder wheel will turn on and start rotating. The grinder wheel will automatically move toward the blade and start grinding. The blade's cutting surface is ground for a short time to sharpen the cutting edge. A steeling device will automatically come in to steel the inside of the cutting edge. The grinder wheel will continue to lightly grind the blade during the steeling operation. When the sharpening process is complete, the steeling device and grinder wheel will automatically retract to their home position and shut off.

The blade can then be removed and the sharpening process repeated for the next blade.



# **Section 3**

## **Unpacking and Installation**

### **CONTENTS OF THIS SECTION**

Unpacking .....	3-2
Included With Your Machine.....	3-2
Installation .....	3-3
Work Station and Lighting .....	3-3



## Unpacking

### Included With Your Machine

The following parts and assemblies are included with your Bettcher® AutoEdge Blade Sharpener. Please check when unpacking and advise your local Bettcher Industries' representative if the delivery is incomplete.

<b>Item Number</b>	<b>Description</b>
1	Eye Shield
2	“Quad” Steeling Device Head
3	Blade Holder Base
4	Blade Holder Screw
5	Washer
6	Grinder Wheel
7	Utility Drawer
Not Shown	Information Sheet (Part Number 185222)
Not Shown	Operator’s Manual

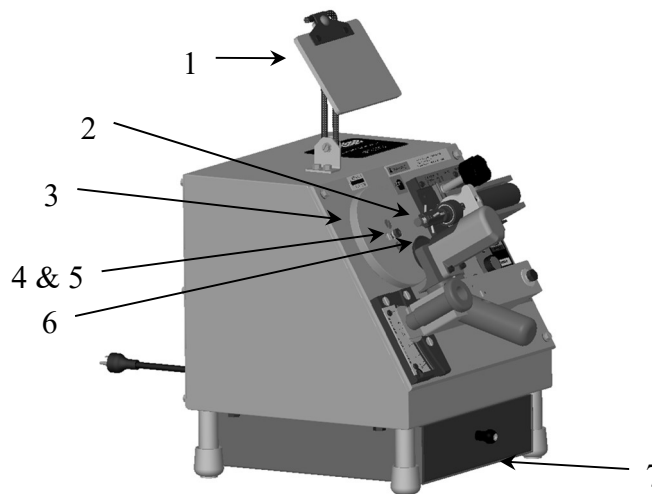

<b>Description</b>	<b>Part Number</b>
<b>Tool Kit</b> (Includes the following):	185299
Dust Brush	120547
7/16 inch Nut Driver	120546
3/32 Hex Wrench	120545
5/32 Hex Wrench	173546



## **Installation**

### **Work Station and Lighting**

Place the Bettcher® AutoEdge on a bench surface of standard working position height. Appropriate lighting should be available. Head and hands are to be kept at a safe distance from the grinder wheel and blade during operation.

**230V Machines Only:** A plug is not provided with this machine. A way to disconnect, in the form of a plug or switch, must be attached to the power cord to assure proper disconnect of all poles.



***THIS PAGE INTENTIONALLY LEFT BLANK***



# Section 4

# Instructions for Operation

## CONTENTS OF THIS SECTION

Instructions for Operation .....	4-2
Information / Operation Sheet:.....	4-2
Attaching the Blade Holder .....	4-2
Installing a Blade for Sharpening.....	4-3
Positioning the Steeling Device .....	4-4
Selecting the Steeling Head .....	4-5
Positioning the Grinder Motor .....	4-6
Grinder Wheel .....	4-7
Sharpening the Blade .....	4-7
Removing the Blade .....	4-8
Check Blade Wear.....	4-9



## Instructions for Operation

*Read Complete Operating Instructions Before Attempting to Sharpen any Blades.*

### CAUTION

THE BLADE HOLDER HAS A PILOT BOSS ON THE BOTTOM WHICH LOCATES ON THE BLADE HOLDER BASE AND A BORE ON TOP WHICH LOCATES THE BLADE. CARE SHOULD BE TAKEN NOT TO DAMAGE THESE SURFACES AS WELL AS THE DRIVE SHAFT. ALWAYS CHECK THAT THESE SURFACES ARE FREE OF GRINDING DUST PRIOR TO ASSEMBLY.

### Information / Operation Sheet:

An information sheet (Part Number 185222) is provided with the sharpener that identifies the steeling device position, steeling device head position, grinder motor position and blade holder to be used with each blade model.

### Attaching the Blade Holder

Refer to the information sheet for the model blade holder to be used. The blade model number and the part number of the holder are etched on the face of the blade holder.

The blade holder base is attached to the blade holder drive shaft with two screws. This blade holder base need not be removed once it has been installed.

***IMPORTANT:*** *Insure all mounting surfaces for the blade holder are clean.*

Place the blade holder on the blade holder base. A pilot boss on the back of the blade holder locates into the pilot bore of the base. Install the blade holder washer and screw through the center hole in the blade holder. **Do not tighten at this time.**

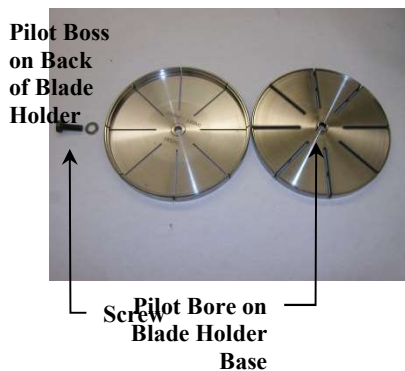







## Installing a Blade for Sharpening



**WARNING**



**SHARP BLADE MAY CAUSE CUT INJURY! FOR PROPER PROTECTION OF HANDS, A PROTECTIVE GLOVE SHOULD BE USED WHEN OPERATING THIS EQUIPMENT AND DURING HANDLING OF BLADES.**

Make certain the proper blade holder is installed.

Check that all inner surfaces of the holder are free of grinding dust.

Place the blade into the blade holder recess. Carefully hold the blade into the recess and tighten the blade holder screw until you feel some resistance against the blade. Hold the outside diameter of the blade holder base and tighten the blade holder screw to fully secure the blade in the blade holder.

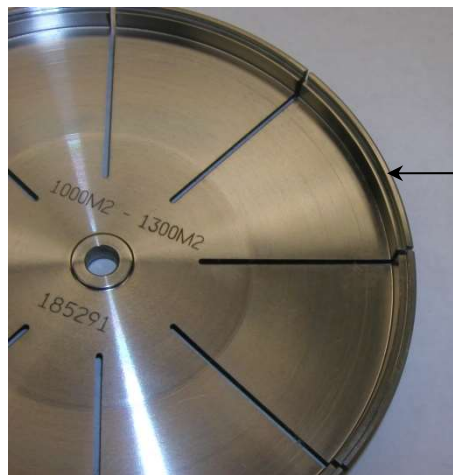

Blade Holder  
Recess for the  
Blade



## Positioning the Steeling Device

Refer to the information sheet for the setting position of the blade model to be sharpened.

The steeling device slides on the steeling base and is secured in place by the lock-down knob. Loosen the lock-down knob. Slide the steeling device assembly so that the indicator mark on the steeling device body lines up with the number line position on the steeling position plate.

Tighten the lock-down knob.



The steeling device is secured in the down position by a spring plunger latch. The steeling device can be pivoted out from the blade holder by pulling up on the steeling device handle.

**Spring Plunger Latch**



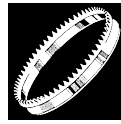

*Instructions for Operation*

---

## Selecting the Steeling Head

Refer to the information sheet for the steeling head setting position of the blade to be sharpened.

The standard steeling head has four steeling rod positions lettered A, B, C and D. To position the steeling head, pull it out fully and then rotate it so that the correct position letter is facing outward. The steeling head will then slide back so that the steeling shaft key slides into the position slot.

The steeling head should slide freely on the shaft against the spring and be guided on the shaft key.

There are special steeling heads for non-standard blade models as indicated on the chart with lettered positions E, F, --etc. These non-standard blade models are listed in Section 7; Service Parts.

To replace the steeling head, remove the steeling shaft screw and slide the spring and steeling head off. Reverse this procedure to install the steeling head.

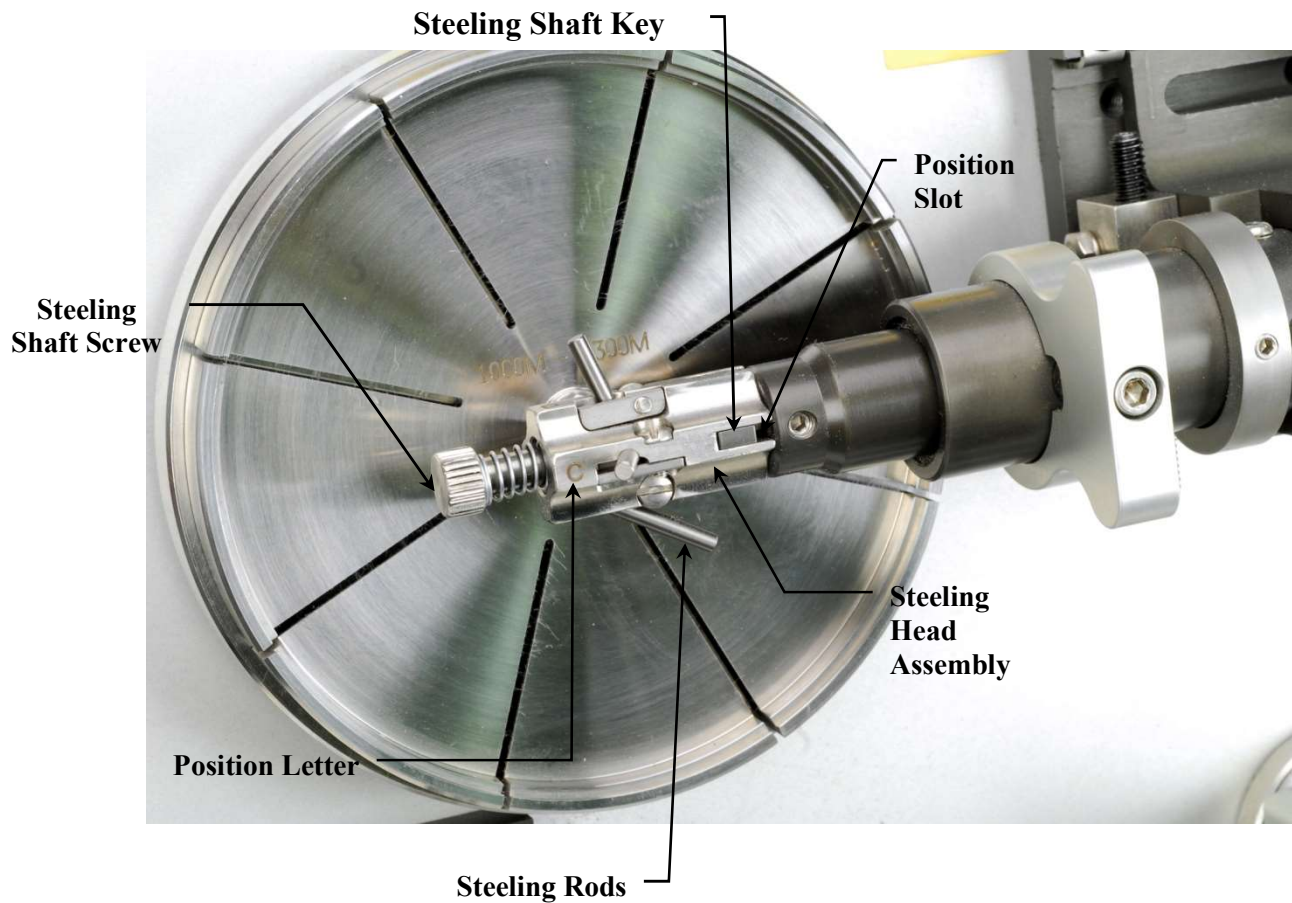



## Positioning the Grinder Motor

Refer to the settings chart for the appropriate grinder motor position of the blade to be sharpened.

Holding the grinder arm handle, loosen the screw inside the grinder arm lock knob, using a 7/16" (11mm) hex nut driver. The grinder arm is now free to slide along the motor position base.

Align the indicator line on the grinder arm's bottom plate to the appropriate number line on the motor position plate and tighten the lock knob screw, using the hex nut driver.

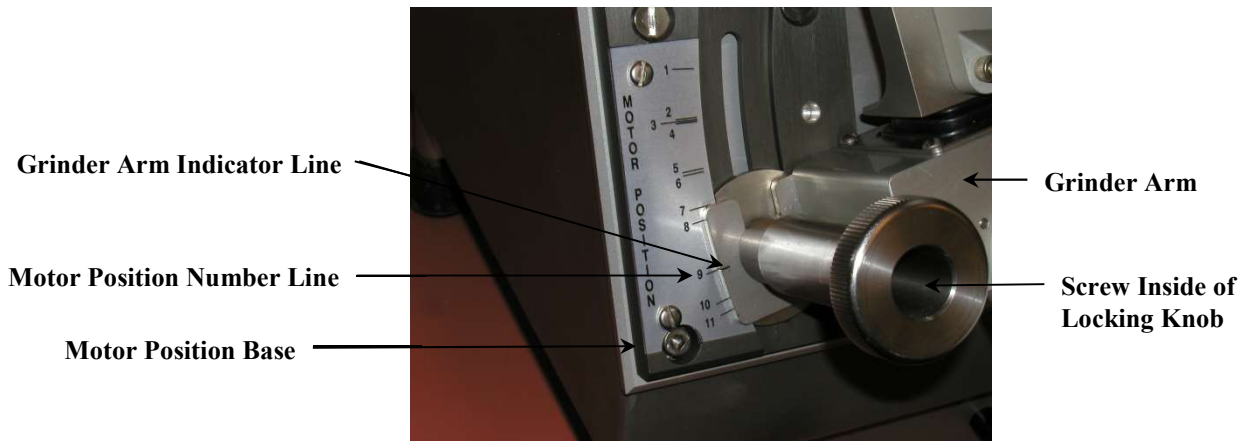

The lock knob can be loosened to swing the grinder arm down out of the way when changing blades, without losing the motor set position. Swing the grinder arm back up against the lock knob post and tighten the knob down to reposition the grinder arm in the grinding position.

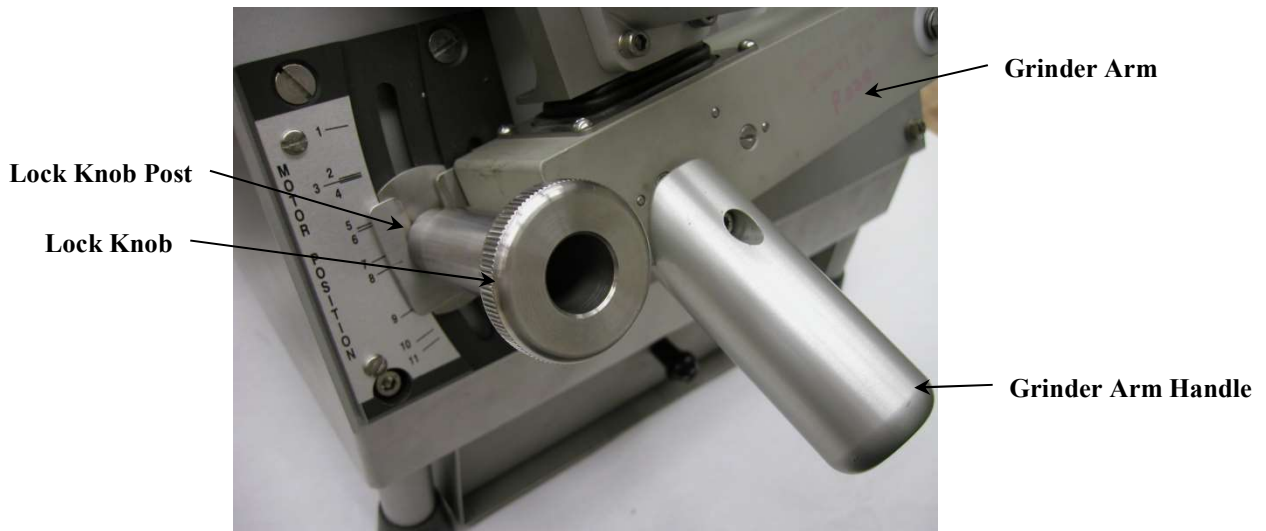

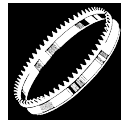

## Instructions for Operation

### Grinder Wheel

This grinder wheel is a CBN (Borazon) plated wheel-form and ***does not*** require dressing of its grinding surfaces. See Section 6 for cleaning.

### Sharpening the Blade



- Eye protection should be worn during the sharpening operation.
- Keep hands away from all moving parts during the sharpening process.
- Position the eye shield over the grind area.
- The sharpening process is fully automatic.
- Insure all settings correspond with the information sheet, the blade is secure in the holder, the grinding arm is in position, and the steeling device is secure in its latch base.

Turn on the power switch. The operation light will turn GREEN, indicating it is ready for the grind cycle operation. Push the GREEN cycle switch to start the grind operation. The grinder motor and blade holder drive motor will start automatically. The grinder wheel will travel into the blade to perform stages of grinding. The steeling head will automatically engage the inside of the blade. The steeling head and grinder wheel will retract when the blade has finished sharpening. The sharpening process can be stopped at any time by pushing the cycle switch.





## Removing the Blade

		<b><u>W A R N I N G</u></b>		
<p><b>SHARP BLADE MAY CAUSE CUT INJURY! FOR PROPER PROTECTION OF HANDS, A PROTECTIVE GLOVE SHOULD BE WORN WHEN OPERATING THIS EQUIPMENT AND DURING HANDLING OF BLADES.</b></p>				

<p><b>C A U T I O N</b></p> <p>AFTER SHARPENING, CAREFULLY WASH THE BLADE WITH HOT, SOAPY WATER AND A SMALL BRUSH.</p>
--

***IMPORTANT:*** *Ensure the grinder wheel and blade has come to a complete stop before removing the blade.*

Swing the steeling device out of the way. Some blades may require that the grinder arm be lowered to remove the blade. Loosen the blade holder screw but do not remove it. Carefully lift the blade from the blade holder.





## **Check Blade Wear**

Blades should be checked after sharpening for their wear height to determine if they should be discarded. Proper blade height effects trimmer operation, steeling device function and performance on its trimming application. Blades that pass through the gauge are worn to the point that they should be discarded. Refer to the accessory listings in the service parts section of the manual to find the blade wear gauges available.



Blades that pass through the gauge should be discarded.



***THIS PAGE INTENTIONALLY LEFT BLANK***



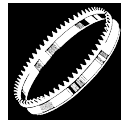

# Section 5

# Maintenance

## CONTENTS OF THIS SECTION

General Maintenance .....	5-2
Grinder Wheel Cleaning, Wear, and Installation.....	5-2
Power Cord Replacement .....	5-2
Fault Detection and Correction .....	5-3
How to read Error Numbers from the Machine: .....	5-3
Fault Detection Guide .....	5-4
Operational Problem Guide.....	5-7
Specific Maintenance Procedures.....	5-9
Cleaning the Steeling Device Assembly.....	5-9
Replacement of Steeling Rod.....	5-12
Adjustment of the Steeling Hold Down Block .....	5-13
Replacement of the Solenoid in the Steeling Device .....	5-14
Replacement of the Grinder Motor .....	5-15
Replacement of the Boot.....	5-16
Remove / Install the Platform .....	5-17
Removal & Installation of the Autoarm Assembly .....	5-18
Replacement of the Feed Mechanism Assembly.....	5-20
Replacement of the Optical Switch Assembly .....	5-22
Replacement of the Drive Motor and Drive Assembly .....	5-23
Removal of the Drive Shaft Bearings .....	5-25
Replacement of the Fan.....	5-26
Replacement and Adjustment of the Signal Device.....	5-27
Removing a Plug from the Controller Board .....	5-28
Replacement of the Microcontroller.....	5-29
Replacement of the Controller Board .....	5-30
Check and Change the Power Supply Fuse.....	5-30
Determining the Cause of a Short at the Controller Board.....	5-32
Electrical Schematics and Wiring Diagrams.....	5-33



## General Maintenance

The Bettcher® AutoEdge blade sharpener has been designed to be practically maintenance free.



## Grinder Wheel Cleaning, Wear, and Installation

- After approximately every 100 blades sharpened, remove the wheel and clean, using a brush and warm, soapy water. For best results, clean with Bettcher **EXTRA** Heavy Duty Cleaner, diluted according to the directions on the container. Rinse thoroughly with water.
- Check for smooth bare metal areas where the grinding material has worn off or chipped.
- To position the grinder wheel on the motor shaft, turn the motor shaft until the flat on the motor shaft is visible through the notch in the platform. Place the grinder wheel on the motor shaft with the set screw aligned with the flat on the motor shaft and the end of the motor shaft flush to the face of the wheel. Then tighten the set screw on the wheel hub.

Setscrew on Wheel

Flat on Shaft

Notch on Platform

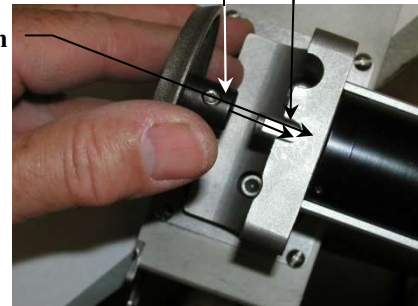

Face of Wheel  
Flush with the End  
of the Motor Shaft

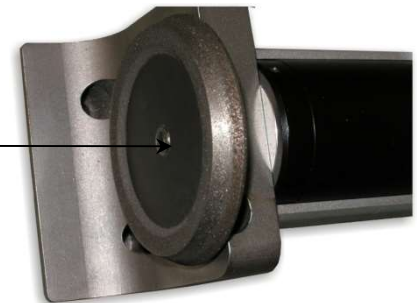

## Power Cord Replacement

- If the power cord is damaged it must be replaced by a qualified electrician.

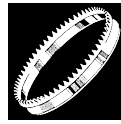

## Fault Detection and Correction

### How to read Error Numbers from the Machine:

When an error occurs during the sharpening process the Bettcher® AutoEdge will abort the cycle and lift the grinding wheel off of the blade. It will then make a “chirp” sound and display a red blinking light. The actual event that caused the error is stored in the machine as a set of two numbers. The first is called the “Group Number” and identifies the general category that the error falls into. The second is called the “Item Number” and identifies the specific event that caused the error condition.

To read the “Group Number” just **press** the Cycle switch. The LED light will blink **Green**, accompanied by short beeps. The number of “green-beeps” is the Group Number. It will be from 1 to 6. If you are not sure you got the count right, just **press** the Cycle switch again. The error numbers are retained until the error is cleared.

To read the “Item Number” you must **press and hold** the Cycle switch until the LED light turns amber (as you hold the Cycle switch, the LED will change from off...to green...to red...to amber, and each change will also have a short beep). Release the Cycle switch while the LED is amber. The LED light will then blink **Red** accompanied by short beeps. The number of “red-beeps” is the Item Number. It will be from 1 to 4.

To identify the problem that caused the error, go to the **Fault Detection Guide** below. The errors are arranged by Group Number and Item Number and are described along with probable cause(s) and corrective action(s) recommended.

To clear the error you must **press and hold** the Cycle switch in until the LED light turns green (at the next beep), then release the cycle switch. The Bettcher® AutoEdge will attempt to reset itself, move the grinding platform to its fully up position and sit idle ready to sharpen a blade. Note that some types of errors (like “**FEED CANT FIND HOME**”) may cause the machine to fall right back into that same error until the cause is corrected. A second way to clear an error is to turn the Bettcher® AutoEdge off at the Power On/Off switch for a moment, then turn it back on. Once the error is cleared it is inaccessible.

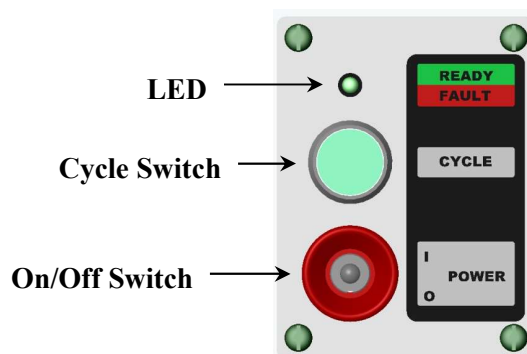



**Fault Detection and Correction (Continued)**

**Fault Detection Guide**

**Group 1:** No Blade Contact: The grinder feed went all the way down, but the grinder wheel did not reach the blade.

<b>ERROR NUMBER</b>	<b>PROBABLE CAUSE</b>	<b>REMEDY</b>
1.1 No Blade Found	Auto arm not set at correct position.	Refer to Positioning the Grinder Motor in the Instructions for Operation section.
	Obstruction preventing platform movement.	Remove obstruction.
	Bad wire connection at feed motor plug.	Check connections at (P3). Check for broken wires at arm pivot.
	Feed mechanism failure.	Consult with Bettcher Service Department.

**Group 2:** Blade or Grinding Problems:

<b>ERROR NUMBER</b>	<b>PROBABLE CAUSE</b>	<b>REMEDY</b>
2.1 Warped Blade	Blade is installed improperly.	Reinstall blade. Ensure all surfaces are clean.
2.2 First Grind Stage	Bad or worn out blade.	Discard blade.
2.3 Second Grind Stage	Grinder wheel is worn.	Clean and/or replace the grinding wheel.
2.4 Third Grind Stage	Blade is installed improperly.	Reinstall blade. Ensure all surfaces are clean.
	Bad or worn out blade.	Discard blade.
	Problem at the controller board.	Check that all wires and plugs are secure. Check that the micro-controller is plugged in fully and pins are not bent or broken.
	Feed mechanism is worn out.	Replace auto arm assembly.

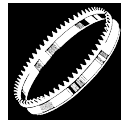

## Fault Detection and Correction (Continued)

### Fault Detection Guide

**Group 3:** Grinder Motor Current.

ERROR NUMBER	PROBABLE CAUSE	REMEDY
3.1 High Motor Current	Motor bearing bad.	Replace grinder motor.
3.2 Weak Motor	Worn brushes.	Replace grinder motor.
	Bad wire connection.	Check that all motor wire connections are secure.

**Group 4:** Grinder Motor Failure.

ERROR NUMBER	PROBABLE CAUSE	REMEDY
4.1 Shorted Motor; Electrical short in the motor circuit	Bad wire connection.	Check that all motor wire connections are secure. Check for broken or worn wire insulation. Replace or repair as needed.
4.2 Motor Overload	Blade is installed improperly.	Reinstall blade. Ensure all surfaces are clean.
	Grinding wheel is worn.	Clean and/or replace the grinding wheel.
	Motor bearing is bad.	Replace grinder motor.
	Feed mechanism is worn out.	Replace auto arm assembly
4.3 Open Motor	Worn brushes.	Replace grinder motor.
	Bad wire connection.	Check that all motor wire connections are secure.



**Fault Detection and Correction (Continued)**

**Fault Detection Guide**

**Group 5:** Feed Mechanism Failure.

<b>ERROR NUMBER</b>	<b>PROBABLE CAUSE</b>	<b>REMEDY</b>
5.1 Feed Mechanism Stuck at Home Position	Optical switch failure.	Check that wire connections are secure at (P3) and (P8). Check for broken wires, especially at arm pivot. Replace optical switch.
	Feed motor failure.	Replace auto arm assembly.
	Feed motor circuit failure in controller board.	Check feed motor winding resistance at connector (P3); red/black = 14.7 ohm green/blue = 14.7 ohm
5.2 Can Not Find Home Position	Bad connection at plug *(P3) or (P8).	Check that wiring is secure at plugs. Check for broken wires at arm pivot.
	Feed mechanism failure.	Consult with Bettcher Service Department.
	Optical switch failure.	Check that wire connections are secure at *(P3) and (P8). Check for broken wires, especially at arm pivot. Replace optical switch.
	Feed motor circuit failure in controller board.	Replace controller board.
5.3 Failed Home Position Signal	Broken or loose wires	Check wire connections at plug. Check for broken wires, especially at arm pivot.
	Worn feed motor lead screw.	Replace auto arm assembly.

**Group 6:** Program Error.

<b>ERROR NUMBER</b>	<b>PROBABLE CAUSE</b>	<b>REMEDY</b>
6.1, 6.2 or 6.3 Internal Error	There is a fault in the controller board or the program encountered an unexpected condition.	Consult with Bettcher Service Department.

\*See Wiring Diagram.



**Fault Detection and Correction (Continued)**

**Operational Problem Guide**

<b>OPERATIONAL PROBLEM</b>	<b>PROBABLE CAUSE</b>	<b>REMEDY</b>
Machine Does Not Power Up When ON/OFF Switch is Turned ON	Damaged power cord or plug.	Replace power cord and/or plug
	Bad ON/OFF Switch.	Check switch connections and wiring. Replace switch.
	Short / overload on 26V output.	See Section “Determining the Cause of a Short at the Controller Board”.
	Fuse on power supply blown.	Replace fuse.
Machine Does Not Function When Cycle Switch is Pushed	Optical switch failure.	Check wiring and connections at (P8)*. Replace optical switch.
	Feed Motor Failure.	Lead screw does not interrupt sensor beam. Replace auto arm assembly.
	Bad Cycle Switch.	Replace Cycle Switch.
Grinder Motor Turns ON when the ON/OFF Switch is turned ON	Controller board circuit damage.	Replace controller board.
Grinder Motor Turns Backwards	Wire connections reversed.	Reverse wire connection at the grinder motor. (Red wire goes on the (+) POS terminal).
Steeling Device Engages When the ON-OFF Switch is Turned ON	Controller board circuit damage.	Replace controller board.
Steeling Device Does Not Engage or Disengage During a Sharpening Cycle	Steeling head and steeling shaft are dirty.	Clean parts.
	Solenoid failure.	Check solenoid wires and plug for loose connections or broken wires. Check solenoid windings with ohm meter: resistance should be 6-9 ohms. Less than 6 ohms, the windings are shorted. More than 9 ohms, the windings are damaged. Replace solenoid.

\*See Wiring Diagram.



**Fault Detection and Correction (Continued)**

**Operational Problem Guide**

<b>OPERATIONAL PROBLEM</b>	<b>PROBABLE CAUSE</b>	<b>REMEDY</b>
Blade Holder Base Does Not Rotate or Chatters and Stalls	Loose wire or plug connection(s).	Check connections.
	Controller board failure.	Replace controller board.
	Mechanical drive problems.	Check that seal is greased. Determine if motor pulley came loose.
	Drive motor winding failure.	Check winding resistance with ohm meter: red to red/white = 2 ohm green to green/white = 2 ohm Replace motor if resistance varies greatly.
Wheel seems to stall for approximately 10 to 30 seconds before continuing towards the blade.	Grinder motor is wearing out. The machine will pause while it attempts to get the motor to run evenly.	Replace the grinder motor.



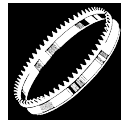

## Specific Maintenance Procedures



Refer to the Service Parts Section 7 for the following Maintenance topics.

### Cleaning the Steeling Device Assembly (See Steeling Device Assembly)

**Cleaning the Steeling Head Assembly:** It is recommended that the steeling head be removed and cleaned every month, or whenever it appears to stick. In normal operation the steeling head should “float” or “follow” on the steeling shaft while steeling the blade.

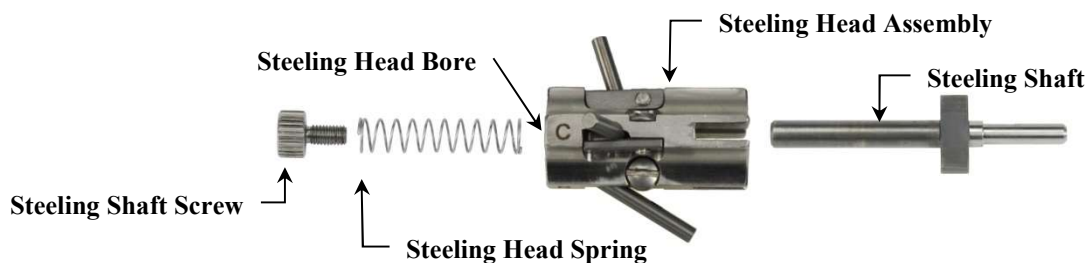

- Remove the steeling shaft screw, the steeling head spring, and the steeling head.
- Clean any grinding dust out of the bore of the steeling head.
- Clean the steeling head shaft and spring. A light greaseless solvent (alcohol or acetone) can be used as long as the parts are dry when reassembled. **Do not use any liquid lubricants on these parts. Liquid lubricants will cause the grinding dust to form a paste.**
- Reassemble the parts starting with the steeling head, then the steeling head spring, and finally, the steeling shaft screw.
- Tighten the steeling screw securely with your fingers.



---

## **Cleaning the Steeling Device Assembly (Continued)**

(See Steeling Device Assembly)

### **Cleaning the Steeling Device Mechanism:**

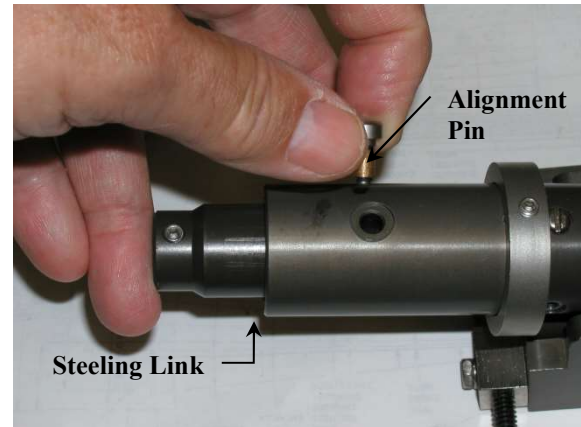
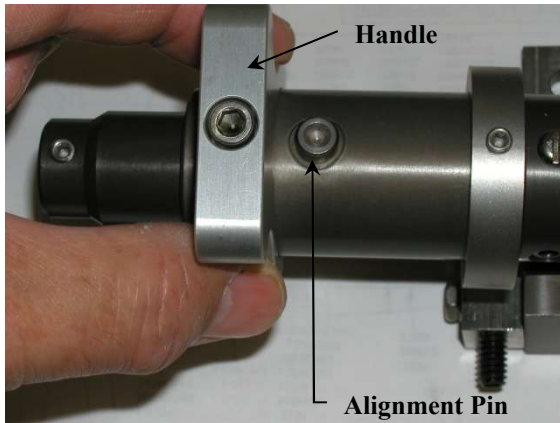

- Loosen the screw from the steeling handle until you are able to slide the handle off the alignment pin.
- Push the steeling link inward slightly to remove the load against the alignment pin and pull the alignment pin out.

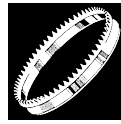

## Cleaning the Steeling Device Assembly (Continued)

### Cleaning the Steeling Device Mechanism Continued:

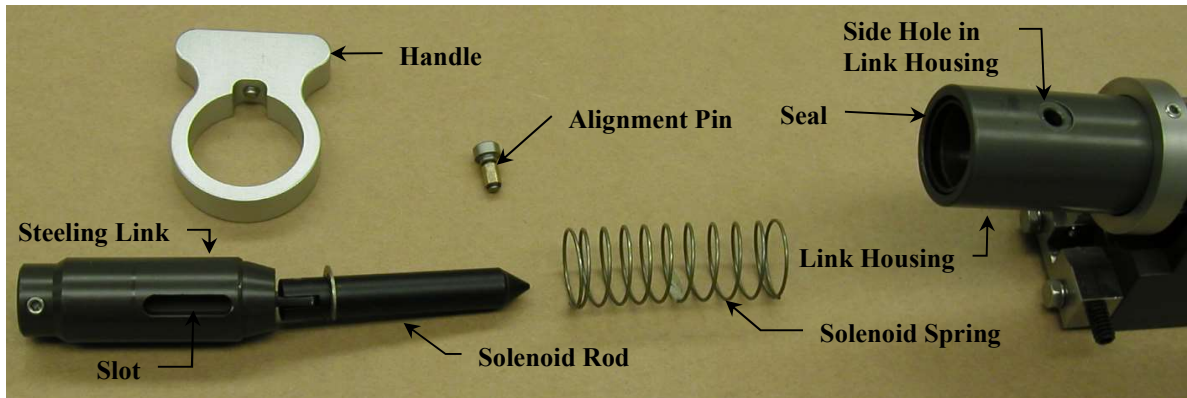

- Pull the steeling link and solenoid spring out of the link housing.
- Use a clean lint free rag to wipe out the bore of the link housing and to clean the seal at the end of this bore (**do not remove the seal unless it is worn and needs replacing**).
- Wipe clean the spring and the steeling link, especially the slot in the link.
- Inspect the roller of the alignment pin for excessive wear. If there is a flat on the roller, or if the groove on the roller is deeper than .150 inch diameter (3.8mm), replace the alignment pin.
- Install the spring back into the link housing.
- Apply light oil (mineral oil, **do not use silicone oils**), to the sliding surfaces, the slot of the steeling link, and to the roller of the alignment pin.
- Be sure the solenoid rod, which is pinned to the steeling link, is clean and dry.
- Hold the steeling link so the slot is aligned with the side hole in the link housing, slide the steeling link into the link housing until the slot is visible through the side hole.
- Insert the alignment pin into the hole and release the steeling link.
- Slide the steeling handle back up onto the alignment pin and tighten the screw.
- Work the steeling assembly in and out a few times to ensure it slides freely, wipe off any excess oil.



## Quad Steeling Head Assembly

### Replacement of Steeling Rod

The Quad Steeling Head Assembly has a body with carbide rods held in place by Clamp Plates and Screws. The Clamp Plate can be loosened to rotate the rod for a new wear surface and for rod replacement.

**IMPORTANT: Make sure the rod(s) are fully seated at the bottom of the counterbore hole in the Steeling Head Body. This assures the proper rod height for steeling the blade.**

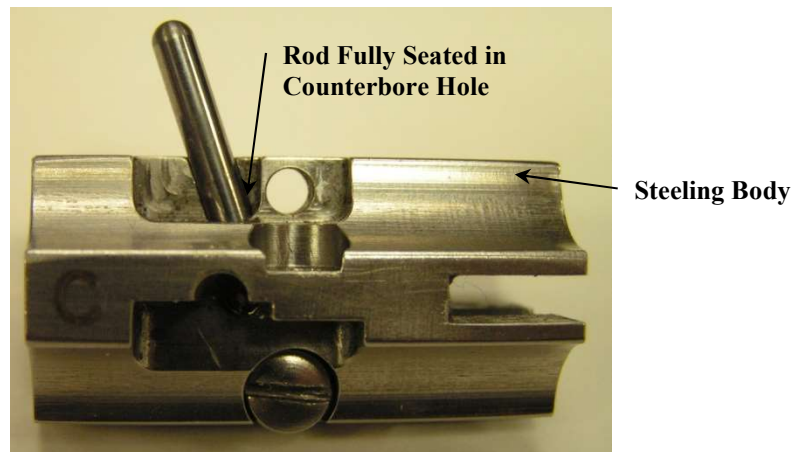
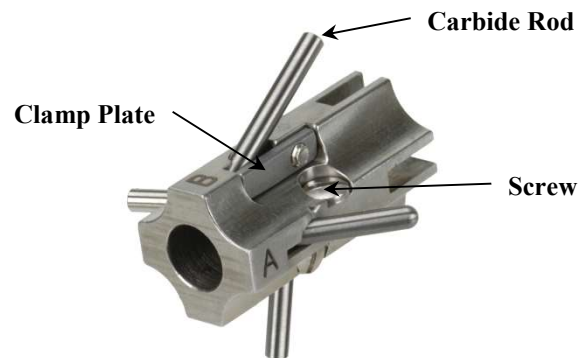

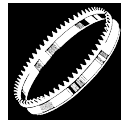

## **Adjustment of the Steeling Hold Down Block**

(See Steeling Device Assembly)

If the steeling device does not clamp down adequately, or if it is too tight in the catch, you can adjust the tension on the spring plungers. To adjust, first raise the steeling device so the catch-tab of the hold down ring lies just above the spring plunger tips. Confirm that the notch in the hold down block is centered on the catch-tab.

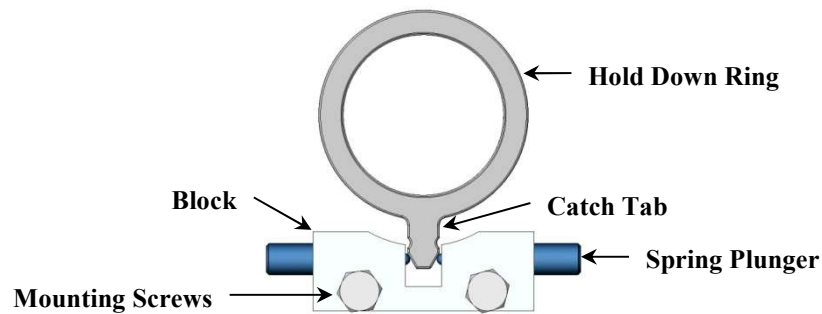

If it is not centered, loosen the two mounting screws, just enough to let the block move, and slide it to center on the catch-tab. Tighten both mounting screws.

View the tips of the spring plungers as they project into the space of the notch. If they are uneven adjust them so that they are even. If the engagement of the catch is too tight or too loose, equally turn the spring plungers very slightly in or out until it feels snug.



## Replacement of the Solenoid in the Steeling Device

(See Steeling Device Assembly)



- Remove the rear panel.
- Disconnect the plug at (P2) on the controller board.
- Remove the two wires from the plug.
- Remove the screw and the solenoid housing cap.
- Raise the steeling assembly so it stands vertical.
- Remove the four screws in the solenoid housing.
- Lift out the link housing along with the entire upper steeling assembly.
- While holding the upper steeling assembly in one hand, use pliers to grasp the body of the solenoid assembly and rotate it counter-clockwise to unscrew it from the link housing.
- Screw the new solenoid assembly into the link housing and tighten with pliers. Do not squeeze too hard on the solenoid body.
- Pass the two wires of the new solenoid assembly into the bore of the solenoid housing and through the wire hole at the other end.
- Remove the knob assembly and the steeling base.
- Install the solenoid into the solenoid housing while pulling the wires through the hole in the back of the solenoid housing.
- Align the steeling handle so it will be facing up, and install the four screws in the solenoid housing.
- Route the two wires through the steeling base, passing them through the grommet in the steeling device slide.
- Swing the steeling device down and snap it into the steeling hold down block.
- Bring the wires from the inside of the cabinet until the tubing portion passes through the grommet by about ½ inch (12mm).
- Set the steeling base into its guide track on the steeling slide and secure it with the knob assembly.
- Install the screw and the solenoid housing cap on the end of the solenoid housing.
- Install the two solenoid wires into the plug (P2) and connect it to the controller board.
- Tighten the end screws on the plug.
- Install the rear panel assembly to the cabinet.

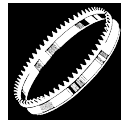

## Maintenance

### Replacement of the Grinder Motor

(See Autoarm Assembly)

**Removal: Turn Power Switch OFF and unplug the line cord from the outlet.**

- Clean the grinding dust from the entire machine.
- Remove the two screws holding the motor cover and slide the motor cover off the motor.
- Disconnect the two wires from the motor terminals.
- Remove the autoarm leaving the cables attached.
- When the autoarm is loose, stand it in the drawer. Loosen the set screw and remove the grinding wheel.

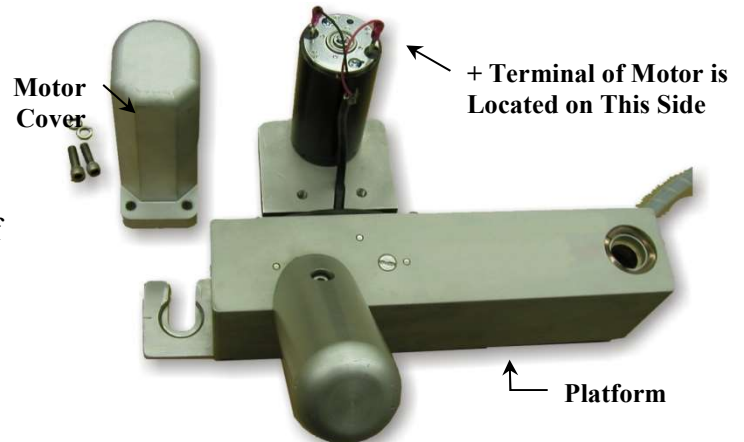

- While holding the grinder motor, remove the four screws holding it to the platform.
- Set the motor and screws aside and brush the grinding dust from the platform.

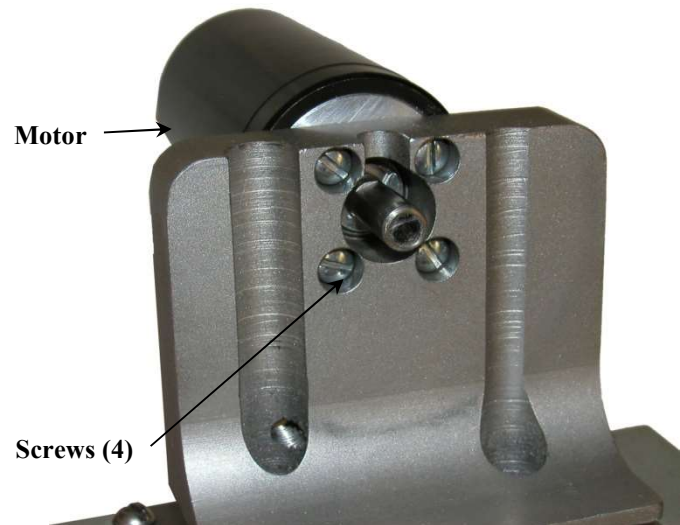

**Installation: Position the replacement grinder motor so the (+) terminal is facing toward the pivot end of the autoarm.**

- Install all four screws loosely before tightening them down. Be careful not to over tighten them.
- Install the grinder wheel on the motor shaft (refer to “Grinder Wheel Cleaning, Wear, and Installation”)
- Connect the red wire to the (+) terminal and the black wire to the other terminal.
- Make sure both connectors are pushed on fully and the terminals are pointing straight up.
- Slide the motor cover over the motor. Fasten it to the platform with the two screws and lock washers.
- Install the autoarm.





## Replacement of the Boot

(See Autoarm Assembly)

- Remove the platform (refer to “Remove / Install the Platform”). Remove the four corner screws of the boot plate and remove the plate and the boot. Clean the grooves the boot seats on, with a vacuum, to keep grinding dust from falling into the feed mechanism.

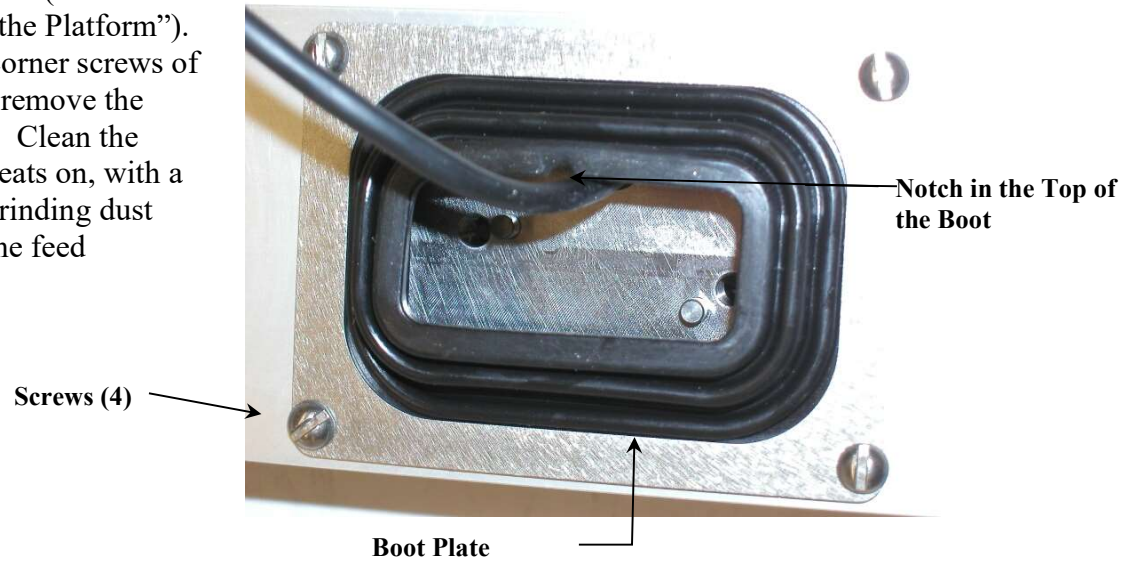

- Position the new boot so the half-round notch is at the top of the arm.
- Set the boot into the grooves in the arm so the bead on the boot aligns with the grooves in the recessed seat.
- Set the boot plate over the boot and install the four screws.
- Install the platform (refer to “Remove / Install the Platform - Installation”).

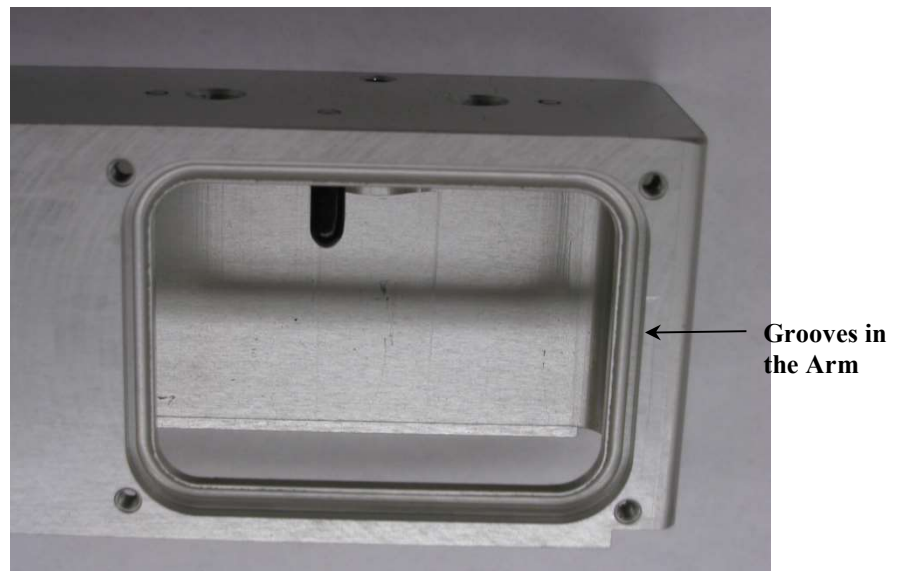



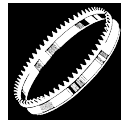

## **Remove / Install the Platform**

(See Autoarm Assembly)

Remove the autoarm assembly, leaving the cables attached.

### **Removal:**

- Remove the grinding wheel.
- Remove the grinder motor cover from the grinder motor and disconnect the two wires from the motor.
- Remove the two socket head screws from the platform.
- Carefully remove the platform from the rubber boot and set it aside.

### **Installation:**

- Hold the platform with the grinder motor over the hole on the boot and push the cable into the notch of the platform.
- With one finger, stretch the lip of the boot over the block of the platform and work the lip into the groove in the block.

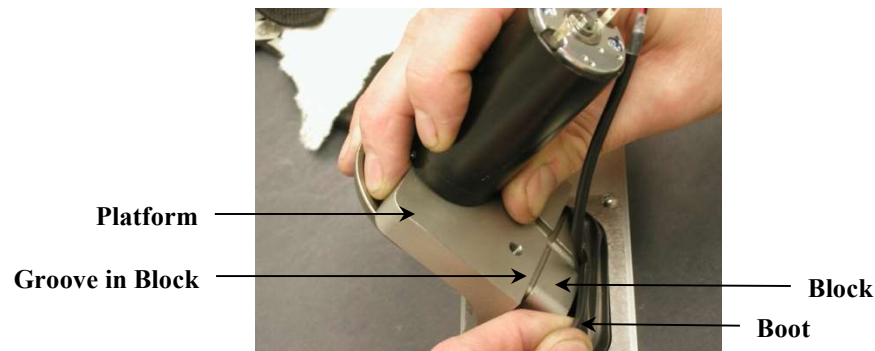

- Align the platform over the two pins in the feed mechanism.
- Tighten the two socket head screws.
- Guide the cable in the notch of the platform. Ensure there is enough free length for the cable ends to fit onto the grinder motor terminals.
- Connect the red wire to the motor terminal next to the (+).
- Connect the black wire to the other terminal.
- Work the lip of the boot all around the platform to be sure it is in the groove and that the half-round notch is over the cable.
- Check that both terminals stand straight up. Install the motor cover.
- Install the grinding wheel (refer to “Positioning the Grinding Wheel on the Motor Shaft”).
- Install the autoarm assembly (refer to Installation of autoarm”).



**Removal & Installation of the Autoarm Assembly**

(See Main Assembly)

**CAUTION**

Clean the grinding dust from the entire machine.

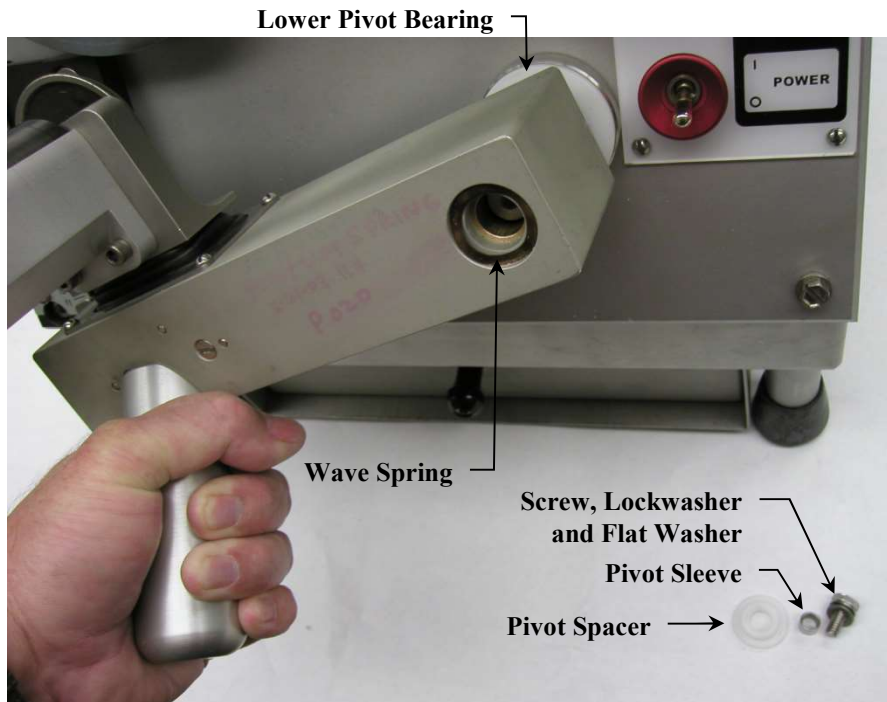

**Removal of Autoarm:**

- Remove the rear panel and disconnect the plugs at (P8) (P3) and (P1).
- Loosen the lock knob screw so the grinder arm is free to pivot down.
- Remove the pivot screw, lock washer, flat washer, pivot spacer, wave spring and pivot sleeve.
- Set all these loose parts aside.
- Swing the autoarm back & forth while sliding it off the pivot post. The lower pivot bearing should stay on the pivot post.
- When autoarm is loose, stand it in the drawer and with one hand pull on the spiral wrap cable while the other hand is guiding it from inside the cabinet.
- Taking one plug at a time, turn the plug sideways and push it into the hollow of the pivot post while pulling on the wires from the outside. When all three plugs are passed through, brush any remaining grinding dust from around the platform.

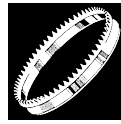

## Removal & Installation of the Autoarm Assembly (Continued)



Plugs Fed  
Through  
the Hollow  
Opening in  
the Pivot  
Post



### Installation of Autoarm:

- Stand the autoarm in the drawer and pass the plugs, one at a time, through the hollow opening of the pivot post with one hand while pulling them with the other hand from inside the cabinet.
- Bring the pivot hole of the autoarm over the pivot post while pulling the spiral wrap cable from inside the cabinet.
- Hold the autoarm in the position it will have when installed so the spiral wrap cable is lined up with the side cutout in the pivot post.
- Push the autoarm onto the pivot post while swinging it back & forth slightly until it slides completely onto the pivot post.
- Swing the installed autoarm into position and tighten the lock knob screw to hold it in place. Be sure the wave spring is in the recess of the autoarm.
- Install the pivot spacer, sleeve, flat washer, lock washer, and screw.
- Tighten the pivot screw.
- Connect the three plugs to (P8) (P3) and (P1) and tighten the end screws on each. Reinstall the rear panel.



## Replacement of the Feed Mechanism Assembly

(See Auto Arm Assembly)

### Removal:

- Remove the rear panel and the autoarm assembly.
- Remove the platform.
- Remove the handle.
- Remove the four ¼ inch hex head screws and the four flat head screws from the arm cover and remove the cover.

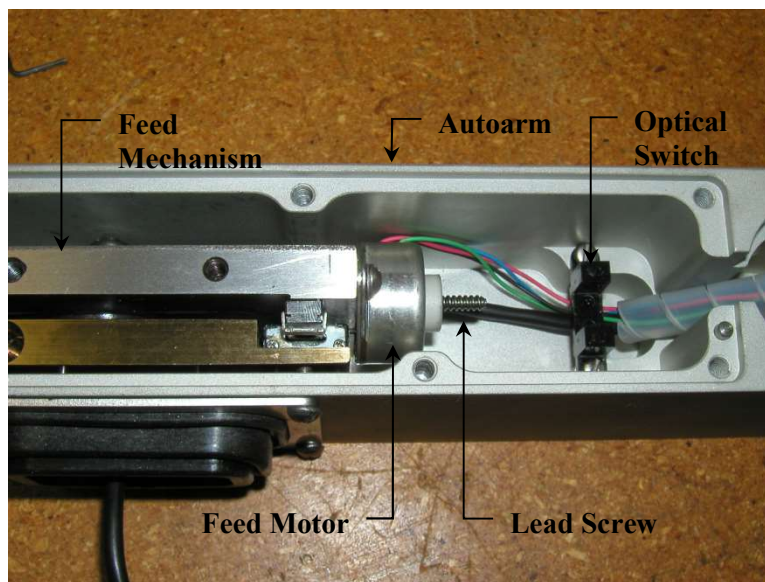

- Remove the two screws on the optical switch.
- Turn the arm over and remove the two flat head screws on the top surface.
- The feed mechanism is now free to be removed from the two alignment pins mounted to the inside of the arm.
- Look through the opening of the boot and note the location of the feed spring as you pull the feed mechanism assembly out of the autoarm. Once the feed mechanism is removed, the feed spring can be set aside.
- Inspect the boot surface for holes or badly worn spots. If any are found, replace the boot.
- Inspect the feed mechanism for grinding dust. If grinding dust is found, use a brush and solvent to clean the lead-screw. DO NOT get solvent inside the feed motor.
- Wipe the lead-screw clean and lubricate with a medium viscosity grease.
- Inspect the sliding surfaces and wipe off any grinding dust. Do not disassemble the feed mechanism. It has been adjusted at the factory.
- Apply a medium viscosity grease to any sliding surfaces that were wiped clean.



## Replacement of the Feed Mechanism Assembly (See Auto Arm Assembly)

### Installation:

- Set the feed spring over the pin inside the arm.
- Make sure the grinder motor cable is routed through the rectangular hole in the feed mechanism block.
- Place the free end of the grinder motor cable into the boot opening.
- Guide the feed spring into the hole of the feed mechanism housing and carefully lower the feed mechanism into the arm.
- With the feed spring in its' pocket, carefully lower the feed mechanism so the spring compresses into the pocket.
- Align the feed mechanism over the two locating pins inside the arm and hold in place with one hand while installing the two flat head screws through the top of the arm.
- Check to see that the grinder motor cable is below the wires coming from the feed motor and the optical switch is under the lead-screw.
- Tighten the two flat head screws.
- Position the optical switch above its mounting holes and set the screws into the mounting holes.
- Screw down the optical switch.
- Install the platform.
- Check that the wires inside the arm are routed away from the optical switch and away from the lead-screw. The wires should be as close to the side wall of the arm as possible. The spiral wrap end should be just inside the arm pocket.
- Place the cover onto the arm, aligned with the two pins.
- Install the four flat head screws and tighten.
- Install the four hex head screws and tighten.
- Install the handle.
- Install the autoarm assembly back onto the machine.

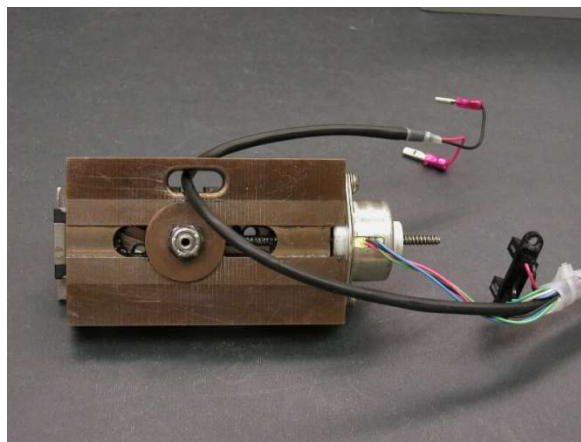

Spring Pocket

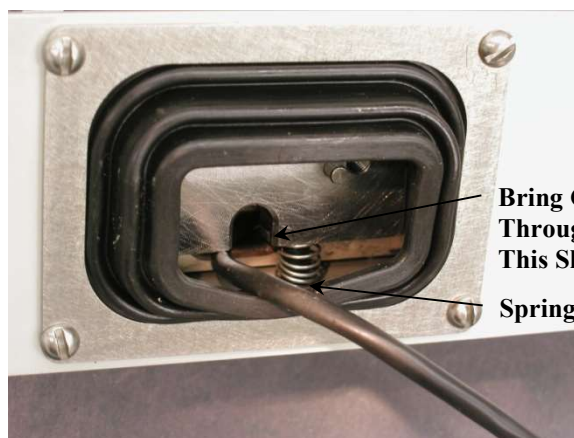

Bring Cable Through This Slot

Spring





## Replacement of the Optical Switch Assembly (See Autoarm Assembly)

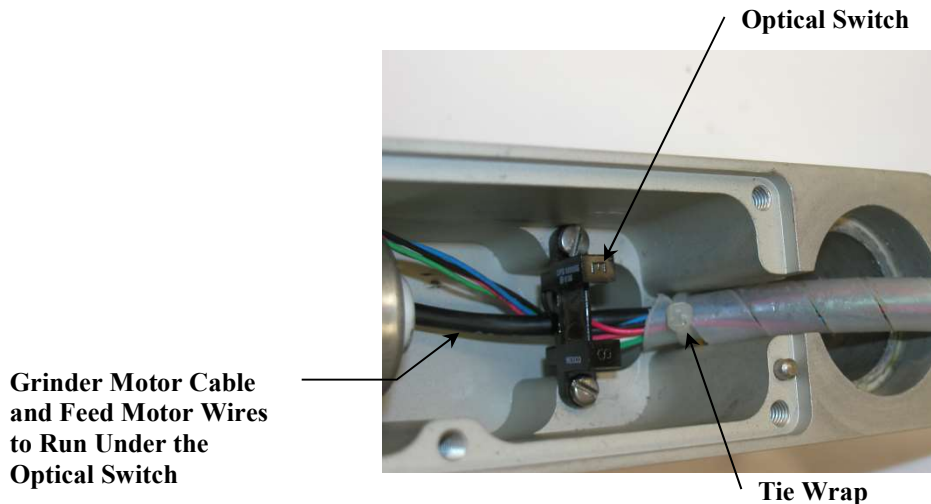

- Remove the feed mechanism assembly.
- Mark the location where the grinder motor cable and the feed motor wires enter the spiral wrap with a piece of tape.
- Remove the tie wrap that is closest to the optical switch.
- Hold the three cables at the plug end with one hand while un-wrapping the spiral wrap until it is totally off.
- Set the old optical switch aside and lay the cable of the new one next to the other cables so the optical switch body is the same distance from the marking tape as the old one was.
- Start the spiral wrap over all the wires at the end closest to the optical switch and continue wrapping it around the wire bundle until it is fully on.
- Attach a new tie wrap over the spiral wrap about  $\frac{1}{4}$  inch (6mm) from the starting end.
- Reinstall the feed mechanism assembly.



*Maintenance*

## Replacement of the Drive Motor and Drive Assembly

(See Main Assembly and Drive Assembly.)

### Removal:

- Remove the blade holder base.
- Remove rear panel and the plug at (P4).
- While holding the drive assembly with one hand from inside the cabinet, remove the four flat head screws that secure the bearing block assembly.
- Take out the drive assembly, set it on the bench.
- Remove the four socket head screws and lock washers and remove the drive motor and timing belt.
- Loosen the set screw in the drive sprocket and remove it from the motor shaft.





## **Replacement of the Drive Motor and Drive Assembly (Continued)**

(See Main Assembly and Drive Assembly.)

### **Installation:**

- Install the drive sprocket onto the new motor with the set screw aligned to the flat of the motor shaft.
- With the flanged end of the drive sprocket about 1/32 inch (.8mm) from the surface of the motor, tighten the setscrew securely.
- Position the drive motor so the wires come out from the top of the motor.
- Place the timing belt around the motor drive sprocket and place the motor up to the standoffs, with the wires at the top.
- Install a screw and lock washer in one of the standoffs closest to the driven sprocket and leave it slightly loose.
- With the motor loose, swing the motor toward the driven sprocket as needed to provide enough slack to get the belt around the driven sprocket.
- Swing the drive motor back to tighten the belt and to bring into alignment with the other three standoffs.
- Attach the remaining three screws and tighten all four.
- Clean the grinding dust from around the base plate lip seal.
- Wipe the drive shaft clean.
- Apply a light coating of grease to the lip seal and to the shaft.
- Install the drive assembly from the inside of the cabinet and through the lip seal. Fasten it with the four flat head screws.
- Connect the plug to (P4) and tighten the end screws.
- Install the rear panel.



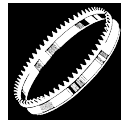

## Removal of the Drive Shaft Bearings (See Drive Assembly.)



Removing the Locknut

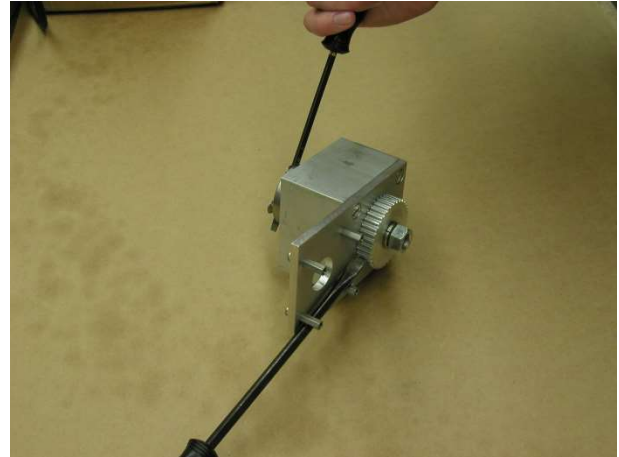

Removing the Pulley

- Remove the drive assembly and drive motor.
- Place two  $\frac{1}{4}$ -20 x 1 inch screws in the shaft holes that were used by the blade holder base, and screw them in about 5 turns. Use a long handled screwdriver or rod to grip between the bolts while loosening the nut with a  $\frac{3}{4}$  inch hex socket wrench. **Note these threads are LEFT HANDED, turn CLOCKWISE TO LOOSEN.**
- Remove the nut and lock washer. Place a screwdriver between the standoffs so the blade is held tightly between two teeth of the driven sprocket. With the long handled screwdriver or rod still between the bolts, rotate the shaft **CLOCKWISE** while the driven sprocket is held by the screwdriver, to loosen the driven sprocket. Once the driven sprocket is loose, it can be unscrewed and the wave spring, preload spacer, lower cone bearing and drive shaft with bearing, can be removed from the housing.
- Clean the bearings thoroughly with solvent and inspect for damage. If either bearing shows damage, the bearings, drive shaft and housing should all be replaced.
- Wipe the housing and bearing outer races clean. Pack the bearings with a general bearing grease.
- Insert the shaft with bearing into the housing. From the other end, insert first the lower cone bearing, then the preload spacer with the shoulder facing outward. Then install the wave spring.
- Hold the assembly vertical with the wave spring facing up, and center it over the shoulder on the spacer.
- Install the driven sprocket, turning it **COUNTER CLOCKWISE**.
- Install the lock washer and nut on the drive shaft and use the  $\frac{3}{4}$  inch hex socket wrench to tighten the driven shaft while supporting the other end of the shaft with the two  $\frac{1}{4}$ -20 x 1 inch screws in the shaft holes.
- Install turntable motor, drive assembly, and rear panel.



## Replacement of the Fan

(See Rear Panel Assembly)

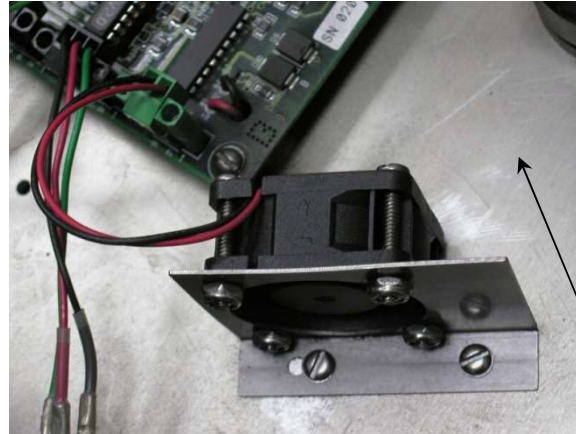

**Fan Air Flow in  
this Direction**

- Remove the rear panel and disconnect the plug at (P6). Note the position of the fan so the wires come out from the top far side and the molded arrow points toward the controller board.
- Remove the four screws and nuts. Remove the fan.
- Mount the replacement fan onto the bracket in the same position as the old one.
- Confirm that the wires and arrow are positioned as described above.
- Connect the plug to (P6) and tighten the end screws.
- Install the rear panel.

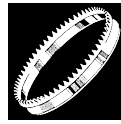

## Replacement and Adjustment of the Signal Device

### Replacement:

- Remove rear panel.
- Disconnect the two wires from the terminals of the signal device.
- Unscrew the plastic ring-nut at the outside of the rear panel and remove the signal device.
- To install the signal device, pass the threaded end through the rear panel from the inside and rotate it as needed to align the flats on the part with the flats of the hole.
- Screw on the plastic ring nut. Hand tighten the ring nut.
- Reattach the two wires to the terminals **being sure to put the red wire on the (+) terminal.**

Signal Device Volume Control



### Adjustment:

- The signal device is mounted on the outside of the rear panel and has a baffle that can be adjusted to control the loudness of the “beeps”. To adjust the loudness, rotate the outer “shutter” disk to increase or decrease. To test the loudness, turn the Bettcher® AutoEdge ON and **hold** the cycle switch in. You will get a beep every 1-½ seconds. If you accidentally start a sharpening cycle, press the cycle switch again to abort the cycle.



## **Removing a Plug from the Controller Board**

- Remove rear panel. Use a small screwdriver to completely loosen the screw at each end of the plug. Grasp the plug and pull it up and away from the controller board.

### **C A U T I O N**

**NEVER DISCONNECT THE MOTOR PLUGS AT (P3) OR (P4) FROM THE CONTROLLER BOARD WHILE THE POWER IS ON.  
SEVERE DAMAGE TO THE CONTROLLER BOARD MAY RESULT.**

- When installing the plugs note that they are keyed and color matched, and that all plugs connect onto the controller board with the side screws facing outward.

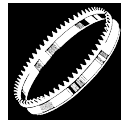

## Replacement of the Microcontroller (See Rear Panel Assembly)

### CAUTION

STATIC ELECTRICITY CAN DESTROY THE MICROCONTROLLER.

- Remove the rear panel and plug (P10) from the controller board.
- Touch the rear panel and touch any nearby grounded devices to make sure you are not carrying any static charge.
- Use a small screwdriver to wedge between the microcontroller and its socket (U6).
- Pry the pins up gently and evenly. Take care not to bend the pins on the microcontroller.

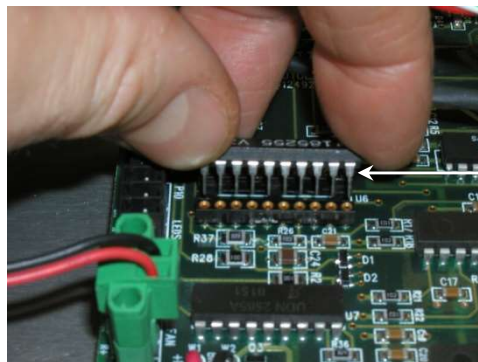

The square mark on the label and the notch on the socket are at this end

- To install the microcontroller, check that all pins are very straight.
- Position the part so the end with the square mark on the label is on the side of the socket with the notch [end furthest from the plug (P10)].
- Line up the row of pins farthest from you with the holes in the socket and let them slide in part way.
- Bring the front row of pins down to align with the front row of holes. Use your fingernail to guide any pins that are not lining up with their holes. When ALL the pins are started in their holes, push the microcontroller downward evenly, rocking from end to end as needed until the pins are all fully into the socket. Inspect the pins to make sure none of them are bent. If any pins are bent, remove the microcontroller, use a pair of needle nose pliers to straighten the pins, and reinstall.



**Replacement of the Controller Board** (See Rear Panel Assembly)

**CAUTION**

STATIC ELECTRICITY CAN DESTROY THE MICROCONTROLLER.

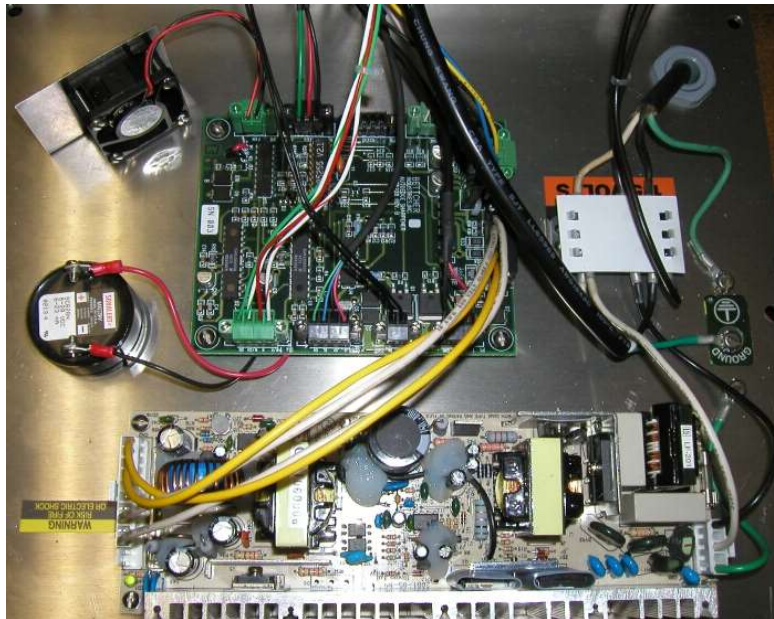

- Remove rear panel and all plugs from the controller board. Touch the rear panel and touch any nearby grounded devices to make sure you are not carrying any static charge. Keep the new controller board in the anti-static bag until ready to install.
- Remove the two wires from the terminals of the signal device.
- Remove the four corner screws from the controller board and lift it off the spacers.
- Place the four spacers over the threaded mounting holes.
- Remove the new controller board from the anti-static bag and align it over the corner spacers, noting position.
- Install the four mounting screws with lock washers into the corner holes of the controller board and pass them through the spacers and into the rear panel.
- First turn the screws down slightly loose so the controller board centers itself then tighten them fully.
- Attach the two wires from the terminals of the signal device.
- Connect all the plugs into their mating sockets. Note that socket (P9) is not used.
- Install the rear panel.



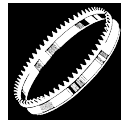





## Check and Change the Power Supply Fuse

(See Rear Panel Assembly)

***This Section is for Service Personnel Only!***



**WARNING**



**THIS SECTION IS FOR SERVICE PERSONNEL ONLY**

**THIS SECTION CALLS FOR TIMES WHEN THE LINE POWER IS TURNED ON WHILE THE REAR PANEL IS OPEN.**

**SOME COMPONENTS OF THE POWER SUPPLY ARE AT INPUT LINE VOLTAGE, AND POSE A SHOCK HAZARD.**

**WHEN WORKING ON THE BETTCHER<sup>®</sup> AUTOEDGE WITH THE REAR PANEL OPEN, AND THE LINE CORD PLUGGED IN, DO NOT TOUCH THE POWER SUPPLY OR TERMINAL BOARD!**

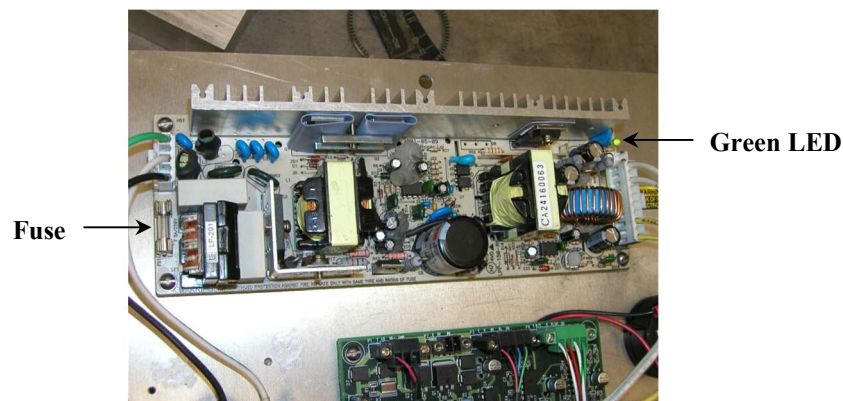

- Remove the rear panel.
- Remove the fuse and inspect. If the fuse is burned out, replace with a size 5 x 20 mm, 5 Amp, fast acting fuse (Buss # GDB-5A, or Little fuse #216005).
- If the fuse was burned out, visually inspect the components on the power supply. If any damage is obvious, replace power supply before attempting to restart. If the new fuse blows replace power supply.
- If the fuse was **not** burned out, but the green LED by the DC output connector is not lit, there is probably an overload in the controller board. The power supply has an automatic shutdown/recovery circuit that will keep the 26 VDC output OFF until the overload is removed. Remove the DC output connector and turn the Power Switch ON. If the green LED on the power supply board lights up, there is a short in the controller board or in one of the attached devices.



---

## Determining the Cause of a Short at the Controller Board

*Read this section through before proceeding.*

Step 1

Perform tests of previous section, “Check and Change the Power Supply Fuse”, to verify that the short is not in the power supply.

Step 2

Unplug the line cord and remove all connectors to the controller board, except the 26V supply connector (P5).

Step 3

Plug in the line cord and turn the machine on. If the green LED on the power supply ***does not*** light, replace the controller board. If the green LED on the power supply ***does*** light, continue.

Step 4

Turn the Bettcher® AutoEdge off and unplug the line cord.

Step 5

Plug in **one** connector at a time, using this suggested order: Solenoid (P2), Grinder (P1), Turntable (P4), Feed (P3), Home (P8), Run/Stop (P7), LED (P10), Fan (P6).

### CAUTION

NEVER CONNECT, OR DISCONNECT, THE TURNTABLE MOTOR (P4), OR THE FEED MOTOR (P3), WHILE THE POWER IS ON. THIS MAY DAMAGE THE CONTROLLER BOARD.

Step 6

Plug in the line cord and turn the machine on. If the green LED on the power supply fails to light, the short is in the last device you connected to the controller board. If the green LED on the power supply is still lit, go back to steps 4, 5 and 6.



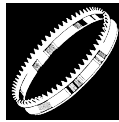

Electrical Schematics and Wiring Diagrams

Electrical Schematic 115V

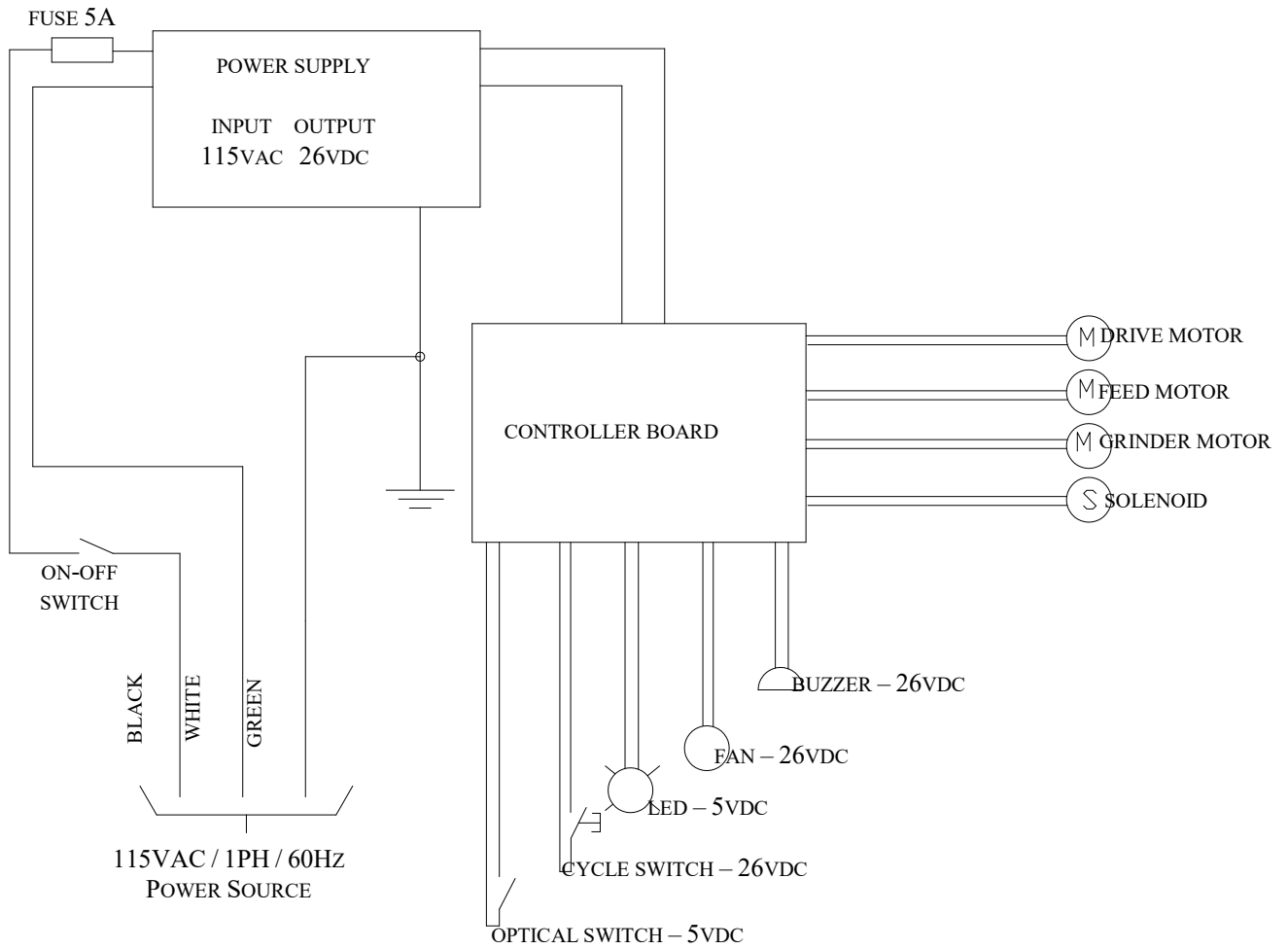



## Electrical Schematics and Wiring Diagrams

### Wiring Diagram 115V

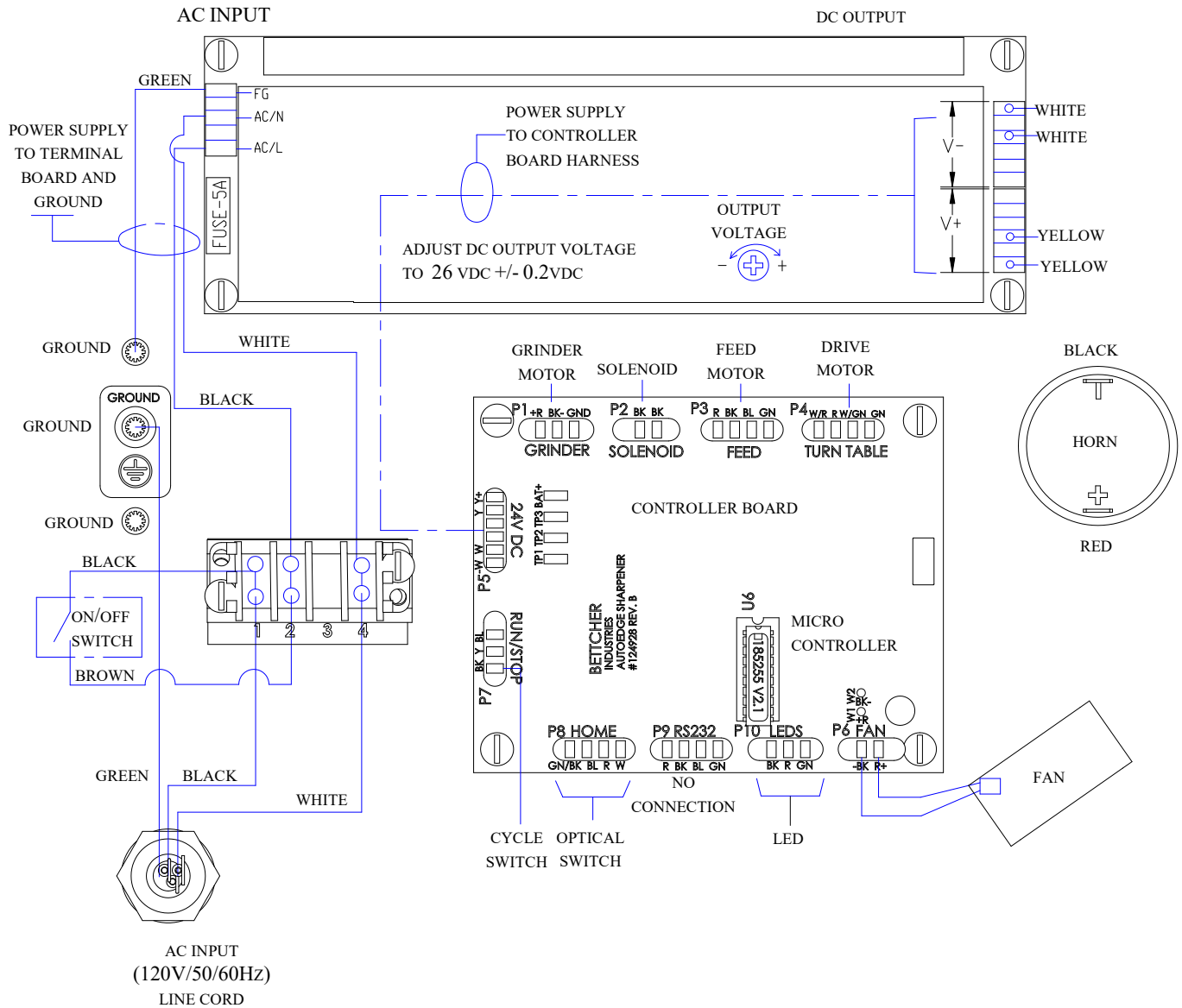

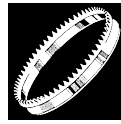

## Electrical Schematics and Wiring Diagrams

### Electrical Schematic 230V

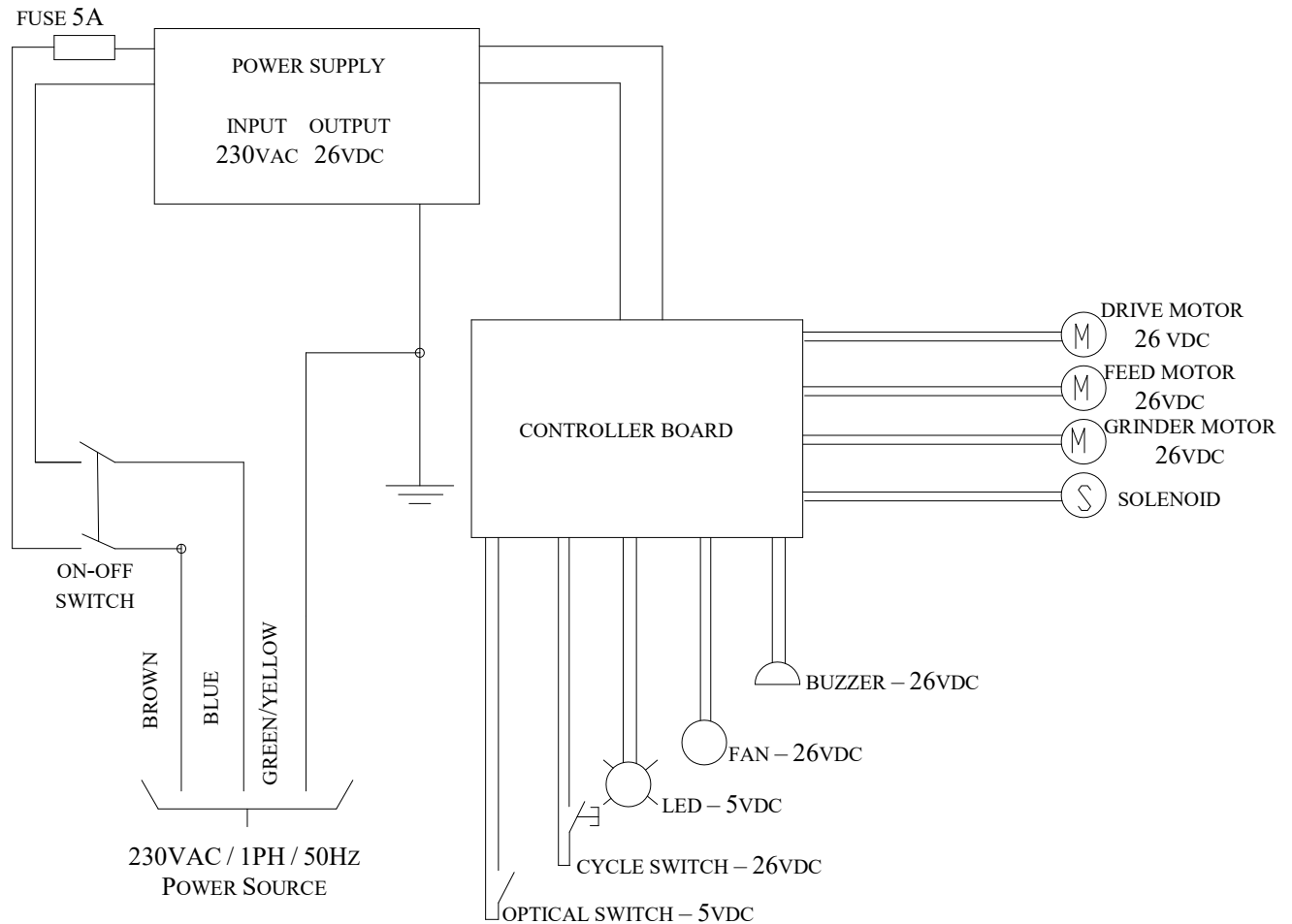



**Electrical Schematics and Wiring Diagrams**

**Wiring Diagram 230V**

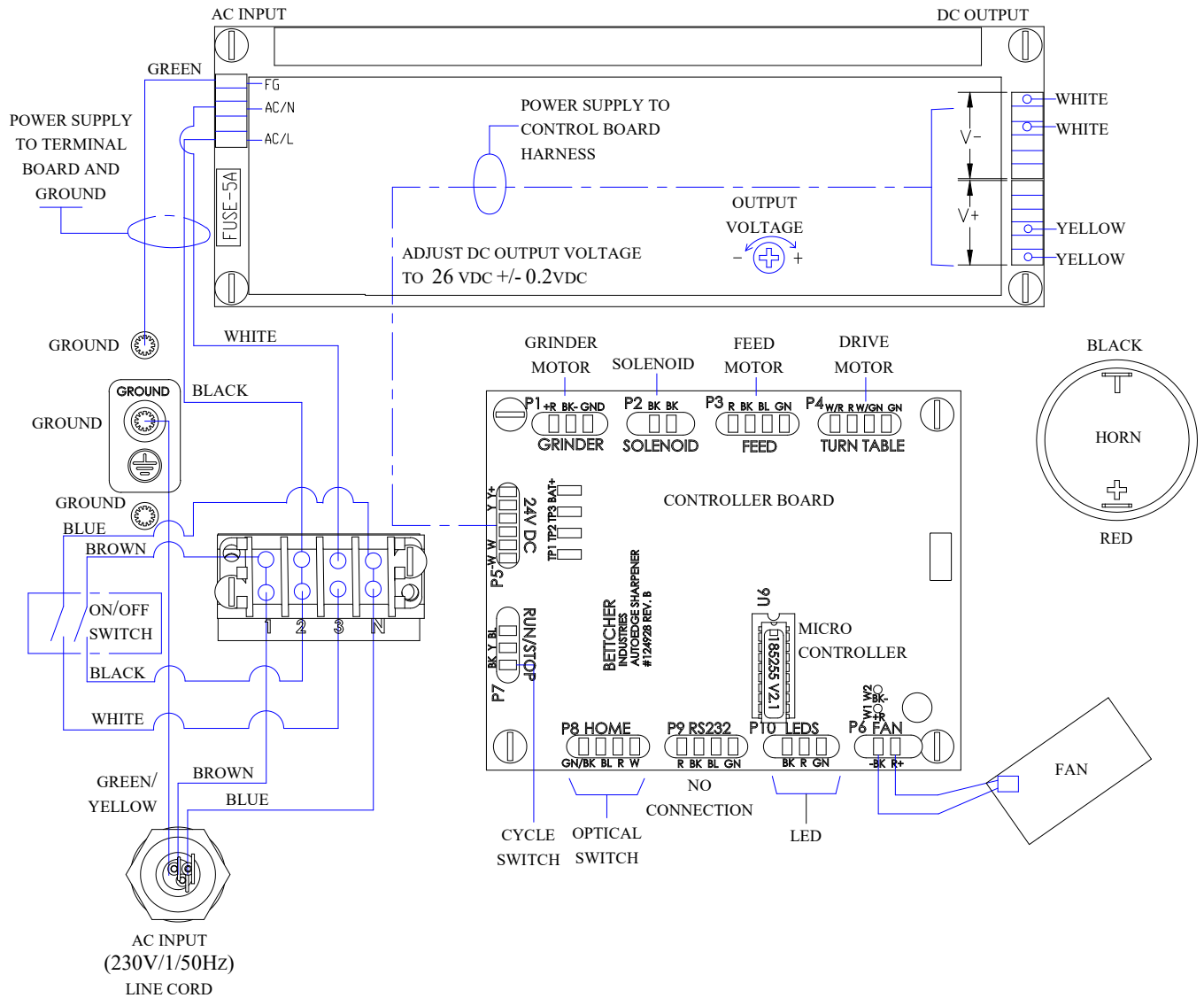

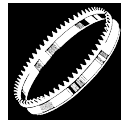

# Section 6

# Cleaning

## CONTENTS OF THIS SECTION

General..... 6-2





---

## General

It is suggested that the sharpener be completely cleaned daily with the use of a small brush and vacuum. ***Do Not*** use a pressure air hose to blow off grinding dust.

It is important to keep all external moving parts and main functional areas clean of excessive grinding dust. This will maintain proper mechanical function of the moving parts and help reduce their wear. Although the unit is enclosed, this will also reduce the possibility of grinding dust getting into the sharpener unit, which could harm the internal components and may cause failures.

		<b><u>W A R N I N G</u></b>	
<b>KEEP THE MACHINE AND SURROUNDING AREA CLEAN FROM BUILDUP OF GRINDING DUST. A BUILDUP OF METAL DUST CAN BE A FIRE HAZARD.</b>			



# Section 7

## Service Parts

### CONTENTS OF THIS SECTION

Main Assembly .....	7-2
Cabinet Assembly.....	7-4
Base Assembly.....	7-6
Auto Arm Assembly .....	7-8
Steeling Device Assembly .....	7-10
Drive Assembly.....	7-12
Rear Panel Assembly .....	7-14
Accessory List - Blade Holders.....	7-16
Accessory List - Steeling Heads.....	7-17
Accessory List - Bettcher® Whizard® Blade Wear Gauges .....	7-19



**Main Assembly**

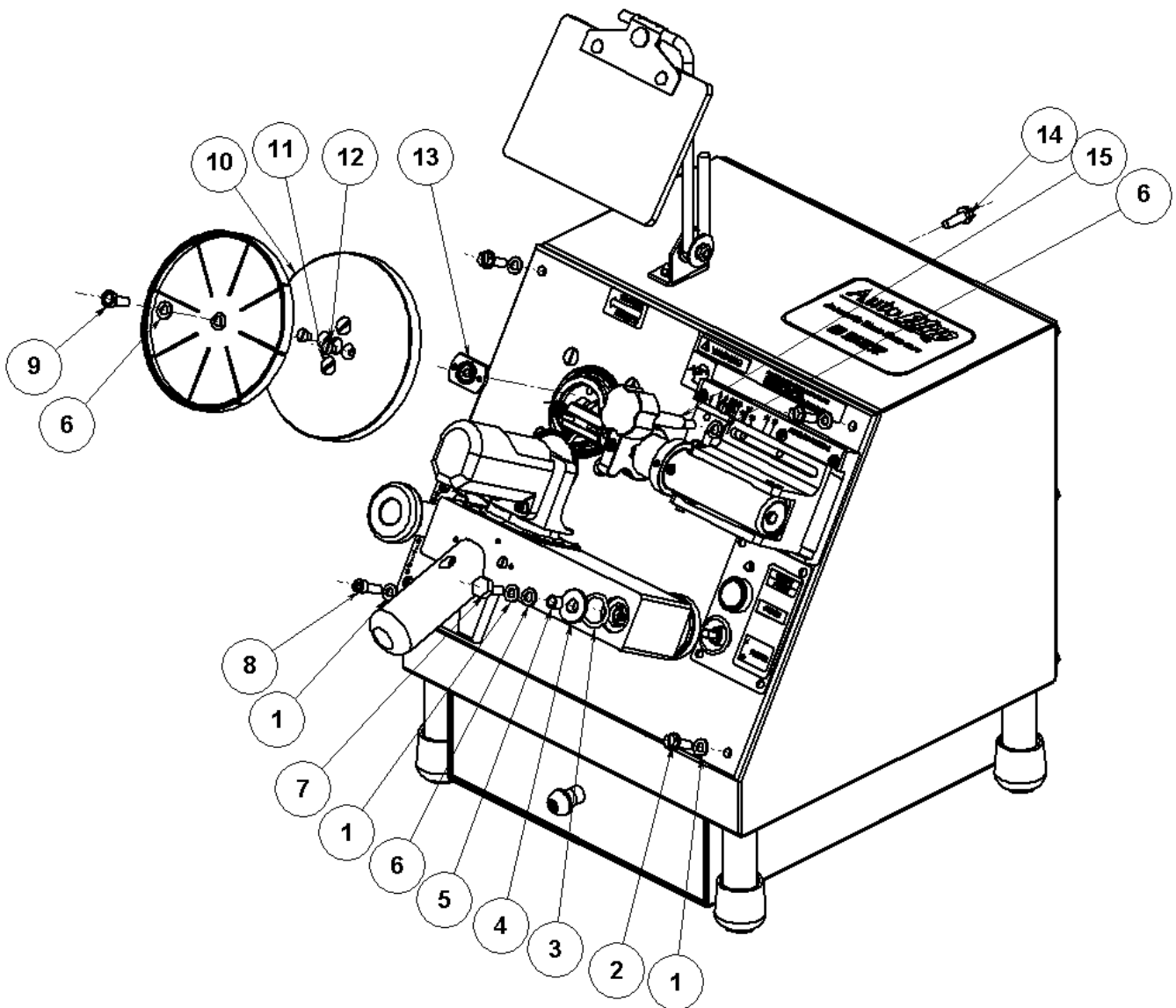



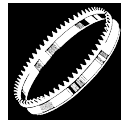

**Main Assembly (Continued)**

Item No.	Description	Part Number	Qty.
1	Lock Washer, 1/4	120220	8
2	Screw, 1/4-20 x 3/4	123264	3
3	Wave Spring	121632	1
4	Pivot Spacer	185196	1
5	Pivot Sleeve	185296	1
6	Flat Washer 1/4	120296	2
7	Screw, 1/4-20 x 5/8	121408	1
8	Screw, 1/4-20 x 3/4	122508	1
9	Blade Holder Screw	185300	1
10	Blade Holder Base	185208	1
11	Screw, 1/4-20 x 3/4	120132	2
12	Screw, #10-32 x 5/16	123257	2
13	Base Nut	185285	1
14	Screw, #10-32 x 1/2	123265	8
15	Lock-down Knob	185156	1



**Cabinet Assembly**

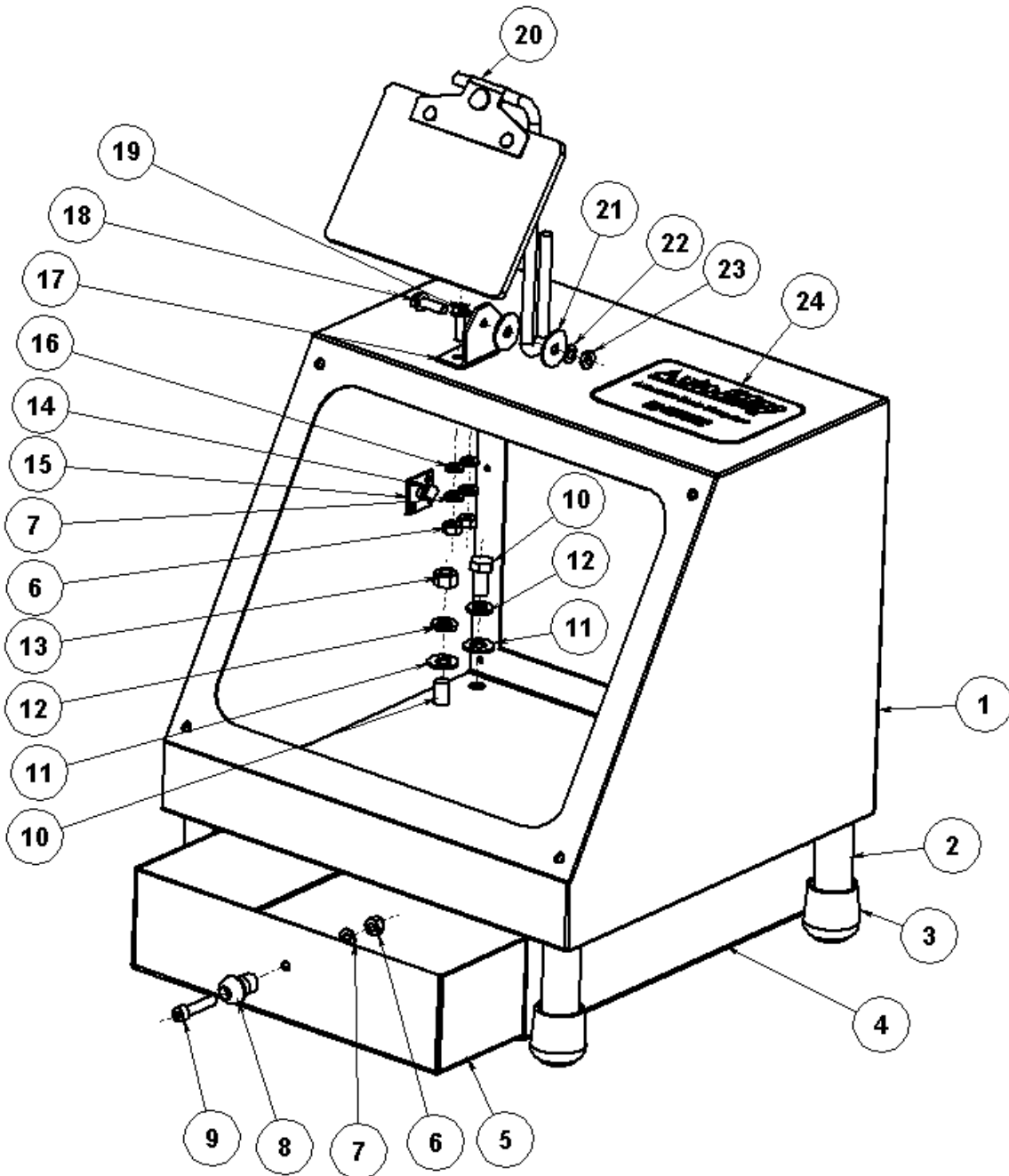

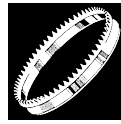

**Cabinet Assembly (Continued)**

Item No.	Description	Part Number	Qty.
1	Cabinet	185151	1
2	Leg	185245	4
3	Leg Tip	185246	4
4	Drawer Bracket	185153	1
5	Drawer	185152	1
6	Nut, 1/4-20	120327	3
7	Lock Washer 1/4	120220	3
8	Knob	113960	1
9	Screw, 1/4-20 x 1-1/4	120570	1
10	Screw, 3/8-16 x 3/4	120048	8
11	Washer, 3/8	120257	8
12	Lock Washer, 3/8	120221	8
13	Nut, 3/8-16	120321	4
14	Clamp	120982	1
15	Tie Holder	124158	1
16	Flat Washer 1/4	120296	2
17	Eye Shield Bracket	185310	1
18	Screw, 1/4-20 x 1	123263	1
19	Screw, 1/4-20 x 3/4	123264	2
20	Eye Shield	185312	1
21	Washer	120273	2
22	Spring Disc	143044	1
23	Locknut 1/4 - 20	120304	1
24	AutoEdge Label	185221	1



**Base Assembly**

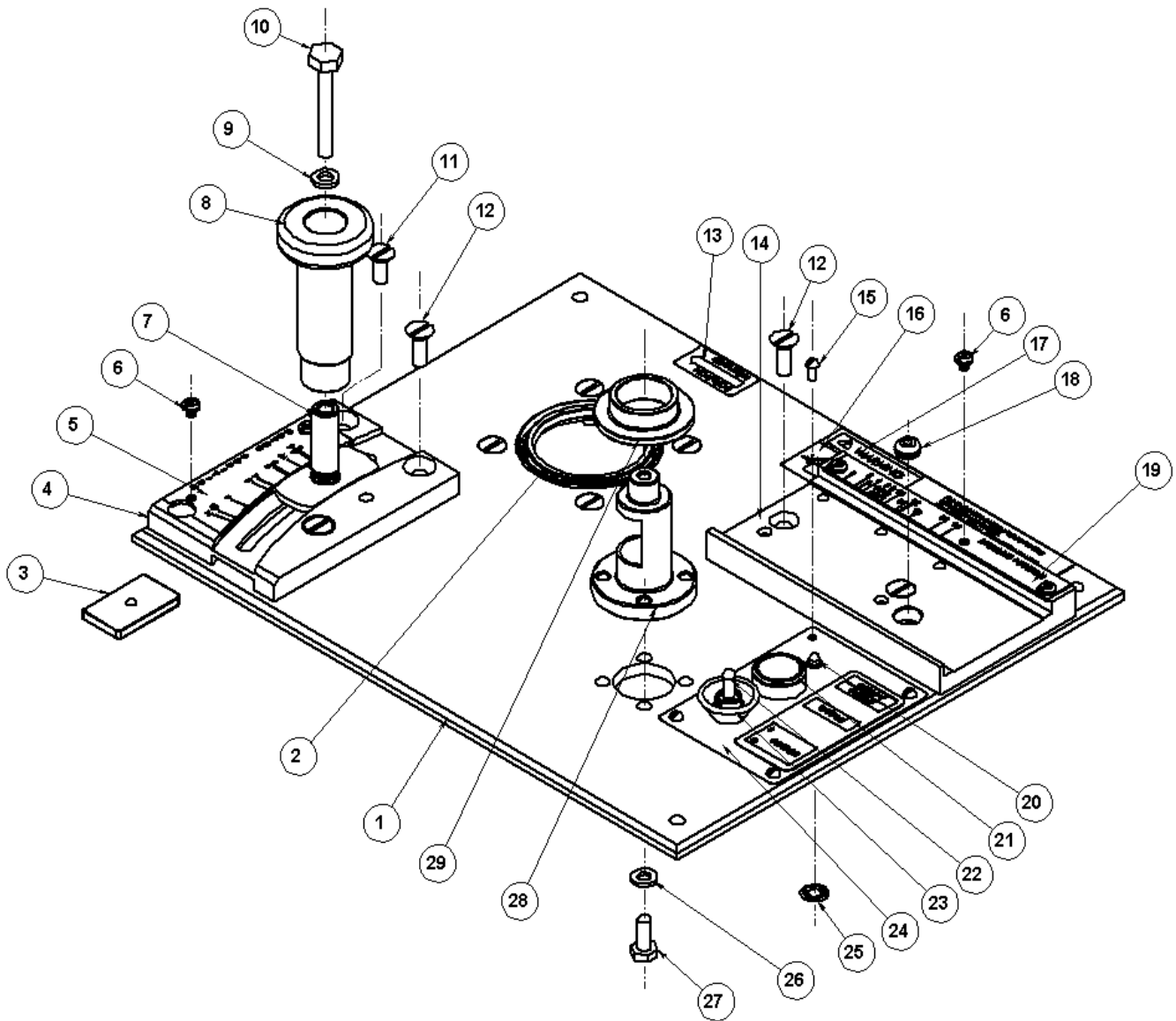



**Base Assembly (Continued)**

Item No.	Description	Part Number	Qty.
1	Base	185155	1
2	Shaft Seal	122326	1
3	Stop Position Nut	185211	1
4	Motor Position Base Assembly	185242	1
5	Motor Position Plate	185213	1
6	Screw, #8-32 x 3/16	123250	5
7	Motor Position Stop	185210	1
8	Lock Knob	185214	1
9	Flat Washer, 1/4	120296	1
10	Screw, 1/4-20 x 2	120773	1
11	Screw 1/4-20 x 5/8	122256	1
12	Screw, 1/4-20 x 3/4	120132	4
13	Rotation Label	108408	1
14	Steeling Device Slide Assembly	185161	1
15	Screw, #6-32 x 5/16	120144	4
16	Eye Hazard Label	108409	1
17	Operation Warning Label	173240	1
18	Grommet	124947	1
19	Positioning Steeling Plate	185159	1
20	LED Assembly	185179	1
21	Cycle Switch Assembly	185231	1
22	On/Off Switch Assembly; 115V	185178	1
	On/Off Switch Assembly; 230V	185315	1
23	Switch Guard	103408	1
24	Control Plate	185177	1
25	Retaining Ring	122046	1
26	Lock Washer, 1/4	120220	4
27	Screw, 1/4-20 x 5/8	120587	4
28	Pivot Post	185197	1
29	Lower Pivot Bearing	185195	1



**Auto Arm Assembly**

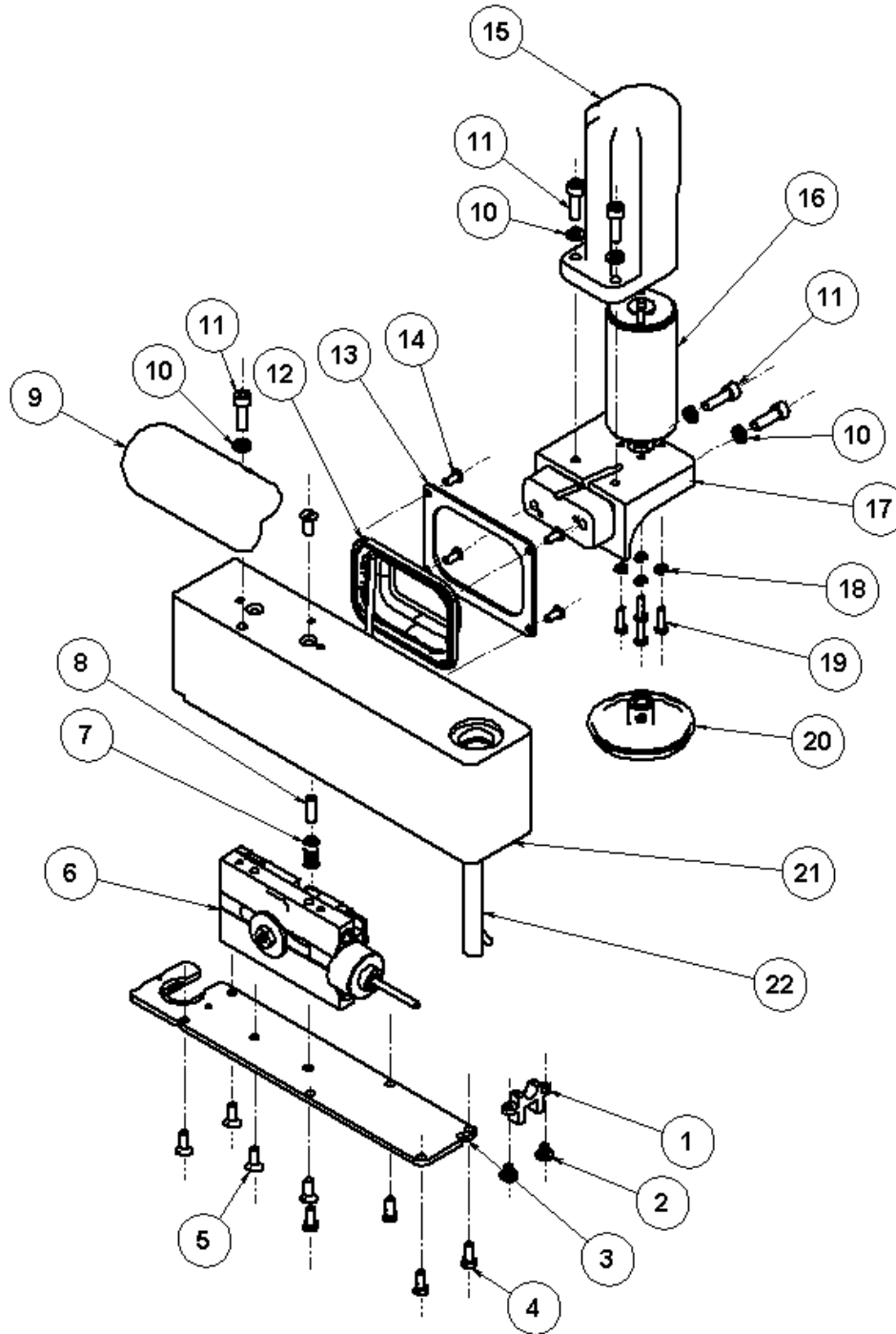

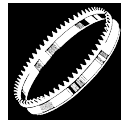

**Auto Arm Assembly (Continued)**

Item No.	Description	Part Number	Qty.
1	Optical Switch Assembly	185194	1
2	Screw, #4-40 x 1/4	120778	2
3	Arm Cover	185266	1
4	Screw, #8-32 x 3/8	120763	4
5	Screw, #8-32 x 7/16	123220	6
6	Feed Mechanism Assembly	185293	1
7	Feed Spring	121643	1
8	Cap	185232	1
9	Auto Arm Handle	185184	1
10	Lock Washer, #10	120237	5
11	Screw, #10-32 x 5/8	122504	5
12	Boot	185198	1
13	Boot Plate	185200	1
14	Screw, #6-32 x 5/16	120144	4
15	Motor Cover	185307	1
16	Grinder Motor	125887	1
17	Platform	185267	1
18	Lock Washer M3	152012	4
19	Screw, M3 x 12 mm	155020	4
20	Grinder Wheel with Set Screw	185262	1
21	Auto Arm with Bearing	185277	1
22	Grinder Motor Cable	185201	1



**Steeling Device Assembly**

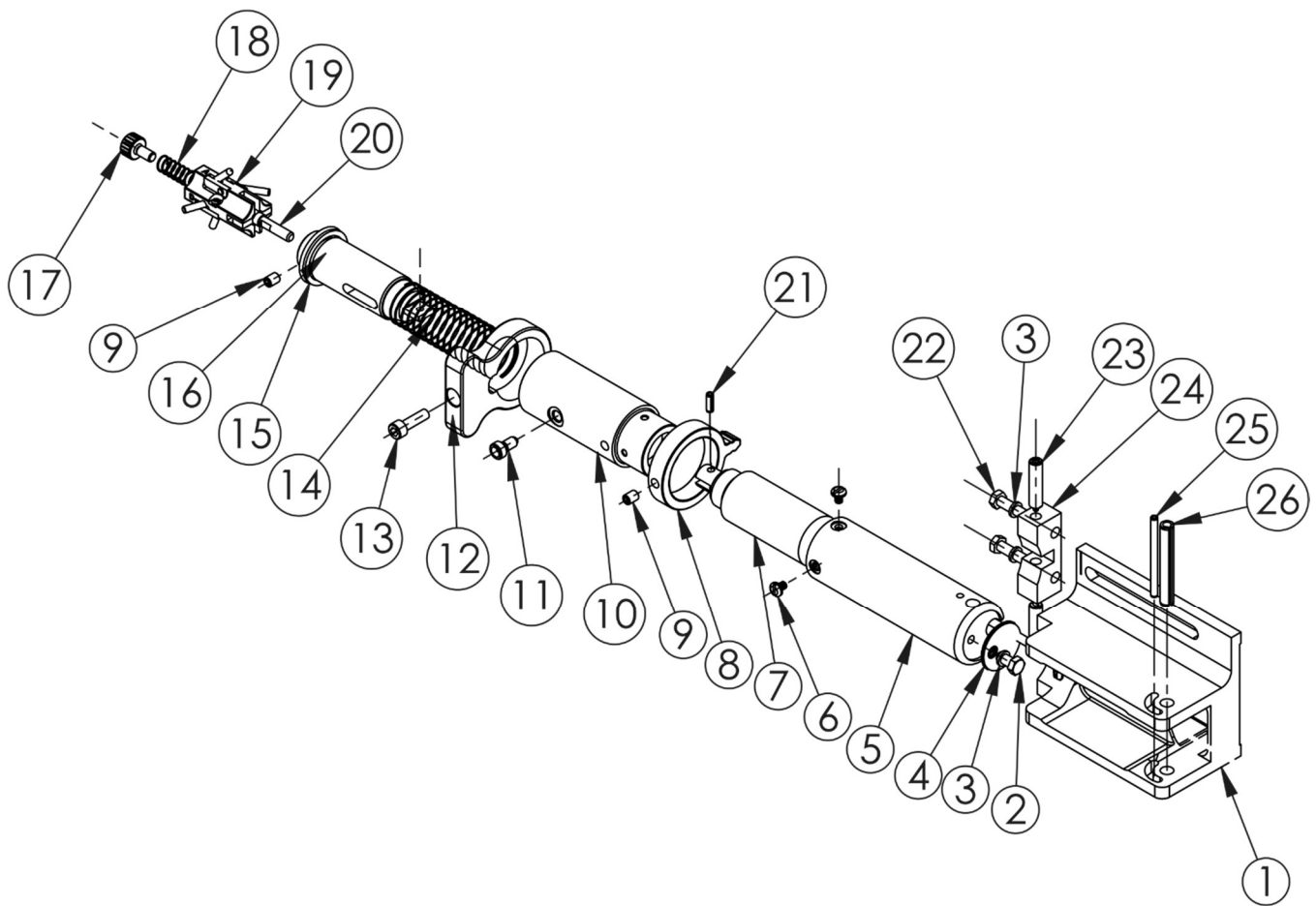



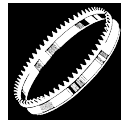

**Steeling Device Assembly (Continued)**

Item No.	Description	Part Number	Qty.
1	Steeling Base	185160	1
2	Screw, #10-32 x 3/8	120757	1
3	Lock Washer #10	120204	3
4	Solenoid Housing Cap	185170	1
5	Solenoid Housing	185164	1
6	Screw, #6-32 x 3/16	123266	4
7	Solenoid Assembly	185166	1
8	Hold Down Ring	185263	1
9	Set Screw #10-32 x 1/4	120053	2
10	Link Housing	185165	1
11	Alignment Link Assembly	107231	1
12	Steeling Handle	185168	1
13	Screw, #10-32 x 1/2	122510	1
14	Solenoid Spring	121641	1
15	Seal	122477	1
16	Steeling Link	185163	1
17	Steeling Shaft Screw	185172	1
18	Steeling Head Spring	121642	1
19	Steeling Head (See Accessory List – Steeling Heads)	185376	1
20	Steeling Head Shaft	185171	1
21	Spring Pin, 1/8 x 3/8	122429	1
22	Screw, #10-32 x 3/4	120766	2
23	Spring Plunger	122789	2
24	Hold Down Block	185264	1
25	Spring Pin – 1/8 x 1-3/4	122443	1
26	Spring Pin, 1/4 x 1-3/4	122442	1



**Drive Assembly**

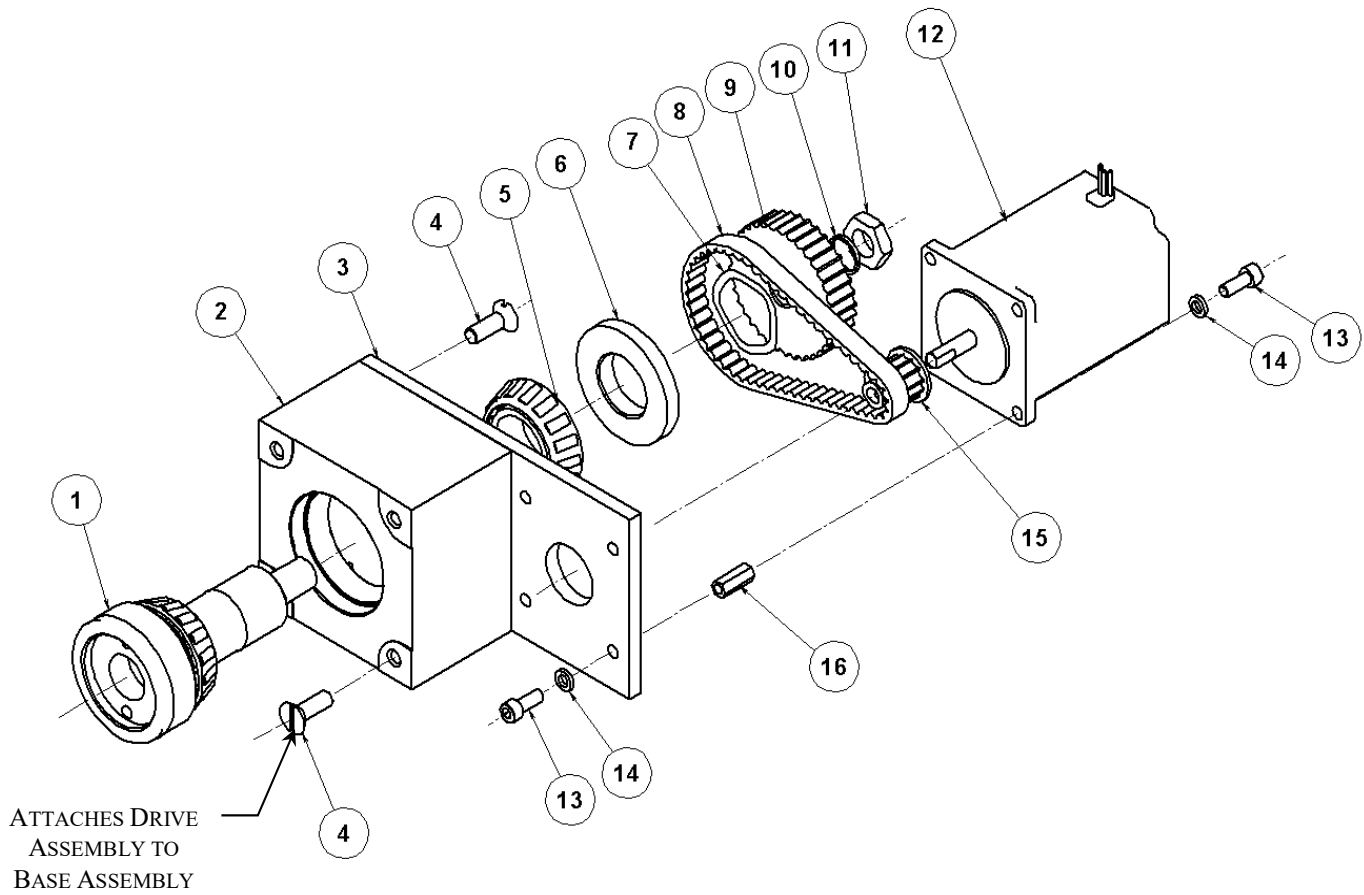



**Drive Assembly (Continued)**

Item No.	Description	Part Number	Qty.
1	Shaft with Bearing	113940	1
2	Bearing Cup Housing Assembly	113959	1
3	Motor Mounting Plate	185215	1
4	Screw, 1/4-20 x 3/4 (Attaches drive assembly to the base assembly)	120132	8
5	Cone Bearing	121741	1
6	Preload Spacer	113957	1
7	Wave Spring	121608	1
8	Timing Belt	125940	1
9	Driven Sprocket	185230	1
10	Lock Washer 1/2	120218	1
11	Nut, 1/2-20 L.H.	123603	1
12	Drive Motor	185216	1
13	Screw, #10-32 x 1/2	122510	8
14	Lock Washer #10	120237	8
15	Drive Sprocket	125941	1
16	Standoff	122785	4



**Rear Panel Assembly**

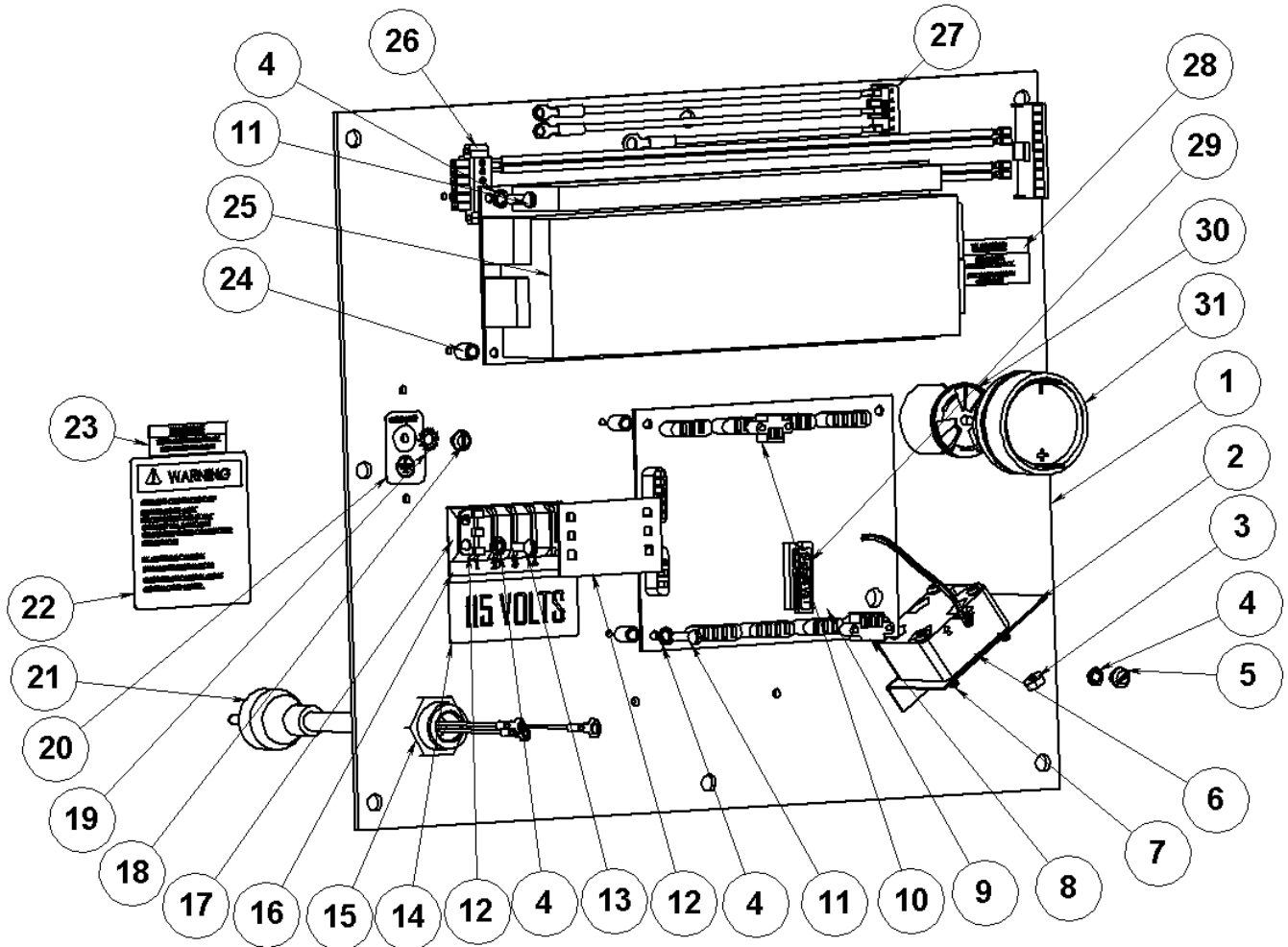



**Rear Panel Assembly (Continued)**

Item No.	Description	Part Number	Qty.
1	Rear Panel	185217	1
2	Fan Mounting Bracket	185218	1
3	Nyloc Nut, #6-32	125608	4
4	Internal Tooth Washer #6	120240	12
5	Screw, #6-32 x 5/16	120696	2
6	Fan	185248	1
7	Screw, #6-32 x 1	120779	4
8	3-Pin Plug (LED)	124943	1
9	Controller Board	124928	1
10	2 Pin Plug (Solenoid)	124919	1
11	Screw, #6-32 x 5/8	120135	8
12	Cover and Bracket Assembly	120967	1
13	Screw 6-32 x 1/2	123214	2
14	115V Label	109080	1
	230V Label	109081	1
15	Connector	123003	1
16	4 Position Marker Strip	124041	1
17	Terminal Block	120966	1
18	Screw, #8-32 x 3/16	123250	3
19	Lock Washer #8	120235	3
20	Ground Label	500715	1
21	Power Cord Assembly, 115V	185219	1
	Power Cord Assembly, 230V	185288	1
22	Warning Label	103709	1
23	Service Warning Label	185301	1
24	Spacer	122788	8
25	Power Supply	124927	1
26	Power Supply/Controller Harness	185244	1
27	Power Supply Input Harness	185240	1
28	Warning Label	185302	1
29	Micro Controller	185255	1
30	Volume Control	124931	1
31	Signal Device	124930	1



**Accessory List - Blade Holders**

<b>Blade Holder Part Number</b>	<b>Blade Holder Model Number</b>	<b>Used With Blade Models</b>
185223	350-620-500M2/Q	350M2/350M2L/Q350/360M2/Q360/620M2/620M2L/Q620/625M2/Q625/500M2/500M2L/Q500/505M2/Q505
105464	X350-X620-X500	X350/X360/X620/X625/X500/X505/ X350LP/X620LP/X500LP
107143	X440-X564	X440/X564
185257	750-850-1850M2/Q	750M2/750M2L/Q750/850M2/Q850/1850M2/Q1850
105446	X750-X850-X1850	X750/X850/X1850/X750LP
185291	1000-1300M2/Q	1000M2/Q1000/1300M2/Q1300
105461	X1000-X1300	X1000/X1300
185227	1930-1940M2	1930M2/1940M2
185234	440M2/Q	440M2/Q
185236	564M2	564M2
185235	754M2	754M2



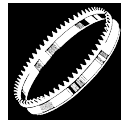

### Accessory List – Steeling Heads

ITEM	Part Number	Description	Used with Blade Model(s)
1	185376	Steeling Head (Quad Assembly)	All Except Those Listed
1A	185176	“A” Steeling Rod	-----
1B	185175	“B” Steeling Rod	-----
1C	185382	“C” Steeling Rod	-----
1D	185382	“D” Steeling Rod	-----
1E	185377	Steeling Head Only	-----
1F	185378	Clamp Plate (4)	-----
1G	120852	Screw #4-40 (4)	-----
2	185228	350M2/M2L/Q	350M2/350M2L/Q350

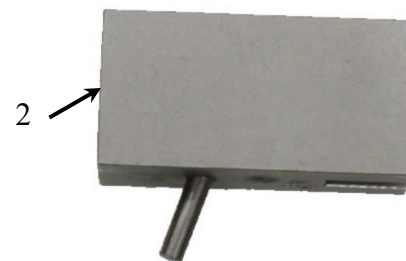
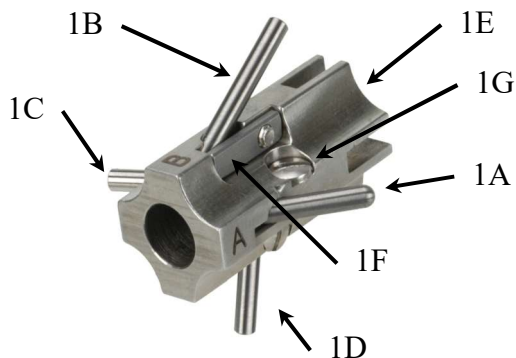



**Accessory List – Steeling Heads (Continued)**

<b>ITEM</b>	<b>Part Number</b>	<b>Description</b>	<b>Used with Blade Model(s)</b>
3	185322	360M2/Q Steeling Assembly	360M2/Q
3A	185323	Steeling Head Only	360M2/Q
3B	185324	Shaft and Rod	360M2/Q
3C	120053	Screw #10-32	360M2/Q

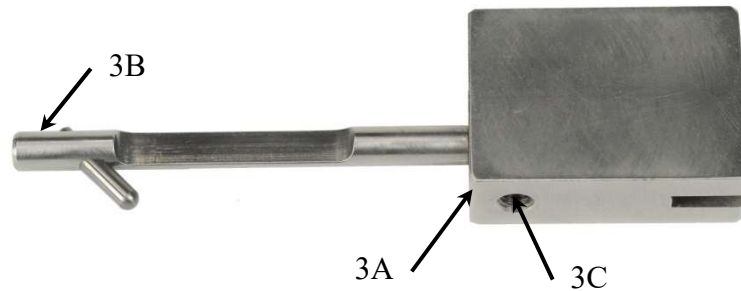



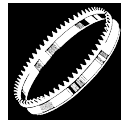

**Accessory List – Bettcher® Whizard® Blade Wear Gauges**



<b>ITEM</b>	<b>Part Number</b>	<b>Used with Blade Model(s)</b>
1	163917	350M2
2	163918	360M2/350M2 Low Profile/Q350/Q360/ X350/X360/X350LP
3	107232	X440
4	173576	620M2
5	163924	625M2/Q625/X625
6	173577	620M2 Low Profile/Q620/X620/X620LP
7	163920	500M2/505M2/Q505/X505
8	173575	500M2 Low Profile/Q500
9	107233	X500/X500LP
10	163922	564M2/X564
11	163925	750M2
12	173578	750M2 Low Profile/Q750
13	107234	X750/X750LP
14	163926	850M2/880M2/Q850/Q880/X850/X880
15	163927	1850M2/1880M2/Q1850/Q1880/X1850/X1880
16	163928	1000M2-1500M2/Q1000-Q1500
17	107235	X1000-X1500



***THIS PAGE INTENTIONALLY LEFT BLANK***

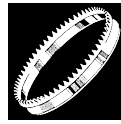

# Section 8

## Contact and Document Information

### CONTENTS OF THIS SECTION

Document Identification .....	8-2
Contact Addresses and Phone .....	8-2



## Document Identification

Copies of this Operation and Maintenance Manual may be ordered by quoting the Document ID as listed below:

Document ID:	Manual #185321
Document Description	Operating Instructions and Spare Parts List for the 115V / 230V Bettcher® AutoEdge Blade Sharpener

Operation and Maintenance Manuals for other Bettcher Industries, Inc. products, such as the Whizard® Trimmers, may be requested by quoting the model designation of the product as shown on the identification plate on the product.

## Contact Addresses and Phone

For additional information, technical support and spare parts, contact your local Bettcher Industries representative, distributor, or:

Bettcher Industries, Inc.  
P.O. Box 336  
Vermilion, Ohio 44089  
USA  
Tel: +1 440/965-4422  
Fax: +1 440/328-4535

BETTCHER GmbH  
Pilatusstrasse 4  
CH-6036 Dierikon  
SWITZERLAND  
Tel: +011-41-41-348-0220  
Fax: +011-41-41-348-0229

Bettcher do Brasil Comércio de Máquinas Ltda.  
Av. Fagundes Filho, 145 Cj 101/102 - São Judas  
São Paulo - SP  
CEP 04304-010 - BRASIL  
Tel: +55 11 4083 2516  
Fax: +55 11 4083 2515

Visit our website at [www.bettcher.com](http://www.bettcher.com)